

ECON I1

control unit for infrared warming cabins

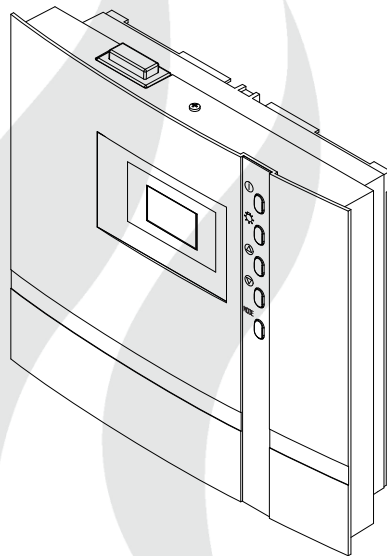

GB Installation and operating instruction

Made in Germany

CE IP x4



English

Table of Contents

Standard delivery	4
Technical data.....	4
General information concerning	5
General safety precautions	6
Installation of the control unit.....	7
Installation	
Surface-mounted installation	8
Recessed installation	9
Connecting the sensor cables.....	10
Installation of the temperature sensor	11
Electrical connections	
Installation of IR-emitters	12
Connecting the cabin lamp	12
Installation and connection overview	13
Terminal layout on the circuit board.	13
Connection diagram.....	14
Operation	
General.....	15
The user interface.....	15
Operating buttons	15
Default display Stand-by.....	16
Default display in operation	16
Energy-saving display	16
Cabin lighting	17
Initial commissioning.....	18
Change language	19
Change time.....	19
Activating the Life-Guard	20
Activate / deactivate the child lock.....	21
Switching on the IR-emitter.....	21

Switching off the IR-emitter	21
Switching on the IR unit with Life - Guard.....	22
Individual settings.....	23
Cabin temperature.....	23
Auto-Stop	25
Life - Guard.....	26
Unit fuses.....	27
Error messages	28
The device switch (Switch-off)	29
Service Address:.....	30
Recycling	30
Guarantee	30
Handling procedures for return shipments (RMA) - Details for all returns.....	31

Standard delivery

(subject to changes)

IR control unit includes the following parts:

1. Temperature sensor, consisting of: sensor circuit board with over-temperature fuse, KTY-sensor, sensor housing, two mounting screws 3 x 25 mm and sensor cable approx. 2 m long (red and white).
2. Plastic bag containing three mounting screws 4 x 20 mm.
3. Spare over-temperature protection fuse

Technical data

Nominal voltage:	400 V 3 N 50 Hz AC
Switching capacity:	max. 9 kW ohmic load (AC1-operation)
Heating time limitation:	6 h
Display:	LCD display 40 x 22 mm, alphanumeric, with backlighting
Dimensions (HxWxD):	220 x 250 x 67 mm
Type of protection:	IPx4 acc. EN 60529 splashproof protection
Temperature control range:	30 to 70°C
Sensor system:	KTY-sensor with safety-temperature limiter 142 °C
Control characteristics:	Digital two-step control
Light output:	max. 100 W
Ambient temperatures:	-10 °C to +40 °C
Storage temperatures:	-20 °C to +70 °C

Dear customer,

with purchase of this infrared control unit you opted for a superior quality, high-tech electronic device which was developed and manufactured according to the highest standards and guidelines.

The following operation instructions describe how to use the control unit. Read these instructions carefully, so that you quickly and easily find your way through the programming process.

General Information



The Infrared-Control unit is equipped as standard for 230 V 50 Hz and has to be protected against short circuit with 16 A fuses.

Dear customer, according to the valid regulations, the electrical connection of the control unit and the electric components has to be carried out through the specialist of an authorized electric shop. Please check the regulations according VDE 0100 Part 703/2006-2.

For failure-free operations, please check the following installation guidelines and manual.

Always heed the specifications and instructions of the cabin manufacturer, too.

General safety precautions

- This device can be used by children aged 8 upwards and by persons with physical, sensory, or mental disabilities, or who have inadequate experience and knowledge if they are supervised or if they have received adequate instruction in how to use the device safely and understand the associated risks. Children may not play with this device. Children may not clean or carry out any user maintenance if unsupervised.
- Children are to be supervised in order to make sure that they do not play with this device.
-  Attention: It is forbidden to install the control box in a closed switch cabinet or behind a wooden panelling!
- The electrical installation may be done only by a qualified electrical technician.
- You must comply with the regulations of your power supply company and applicable VDE regulations (DIN VDE 0100).
-  WARNING: Never attempt repairs or installations yourself, as this could result in serious injury or death. Only a qualified technician may remove the housing cover.
- Please note the dimensions in the assembly instructions, especially when installing the temperature sensor. The temperature above the oven is critical for the temperature setting. The temperature can be held within operating parameters and a minimal temperature gradient inside the the cabin can be achieved only if unit is assembled correctly.
- The device may only be used as intended as a control unit for IR-emitter up to 9 kW (up to 36 kW when combined with a contactor box).
- Completely disconnect the control unit from the electrical circuit, i.e. flip all circuit breakers or the main circuit breaker during each installation or repair.
- Please note the safety and installation information from the IR-emitter manufacturer.
- Always heed the specifications and instructions of the cabin manufacturer, too.

 Attention!

Dear customer,
according to the valid regulations, the electrical connection of the emitter and the control box has to be carried out through the specialist of an authorized electric shop

We would like to draw your attention that in case of a warranty claim, you are kindly requested to present a copy of the invoice of the executive electric shop.

Installation of the control unit

Wall installation

The control unit may only be mounted outside the IR-cabin. It is advisable to select the outside wall of the cabin to which the IR-emitter is fixed from the inside as mounting position. If ductwork is already provided for electrical installations then the position of the control unit is predetermined by that. Please follow the instructions for installation:

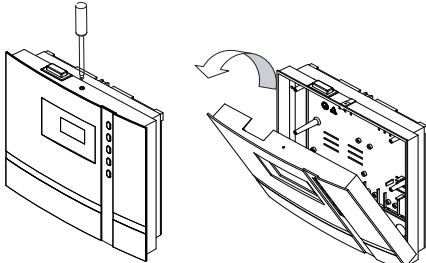

Fig. 1

Remove the control device cover. In order to do this loosen the screw at the top of the housing and pull the housing top upward while swiveling (Fig. 1).

Surface-mounted installation

1. The 3 mm diameter boreholes for the supplied wood screws 4 x 20 mm are drilled according to the dimensions shown in Fig. 3 + 3.1.
2. Insert one of the wood screws into the top center hole. The control unit is hooked onto this screw. Therefore, leave the screw out by approx. 3 mm (Fig. 3.2).
3. Hook the control unit onto the 3 mm protruding screw in the upper mounting hole. Insert the supplied rubber grommets into the openings at the rear wall of the housing and insert the connecting cable through these openings.

Fasten the housing bottom at the two bottom openings (Fig. 4) firmly to the cabin wall.

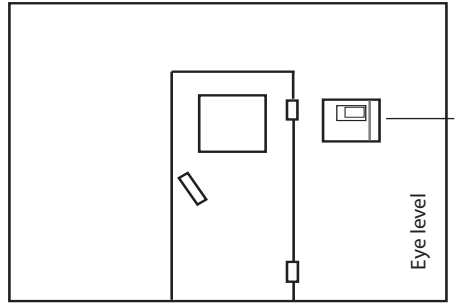

Fig. 3

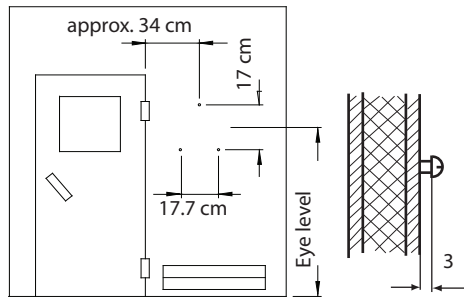

Fig. 3.1

Fig. 3.2

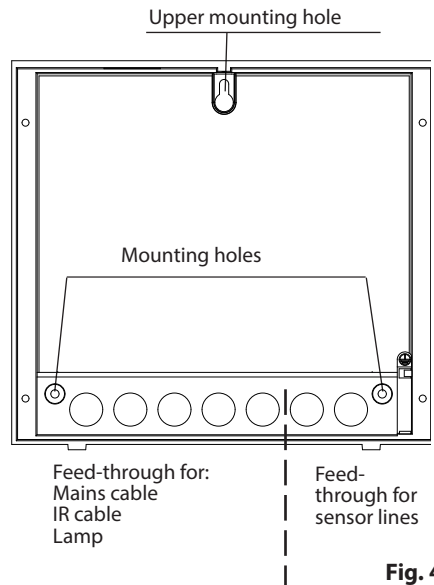

Fig. 4

Recessed installation

1. Cut out a wall section that is at least 3.5 cm deep according to the dimension in Fig. 5.

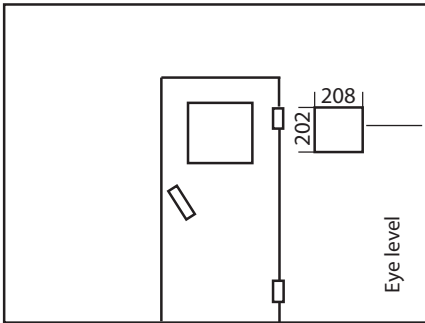

Fig. 5

Insert the supplied rubber grommets into the openings at the rear wall of the housing and insert the connecting cables through these openings.

Place the control unit into the wall opening and fasten it with 4 wood screws.

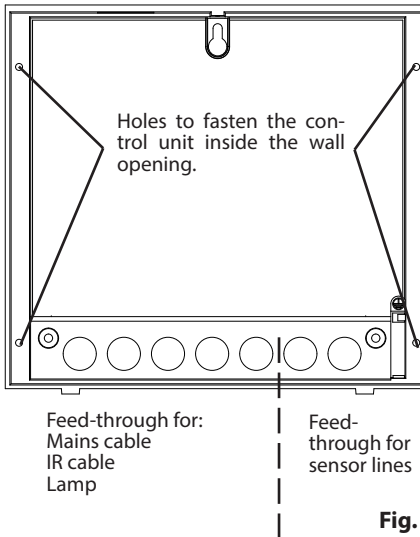

Fig. 6

Connecting the sensor cables

You should not install sensor and power supply lines together, or lead them through the same feedthrough. This can lead to interferences in the electronics, such as "fluttering" in the relays. If it is necessary to lay the cables down together, or if the line is longer than 3 m, use a shielded sensor cable (4 x 0.5 mm²).

Connect the shielding to ground in the control unit.

Please observe that the following dimensions relate to the values stipulated during the unit inspection acc. EN 60335-2-53. The heater sensor must always be installed at the point where the highest temperatures are to be expected. Illust. 7-9 give you an overview of the mounting point of the sensor.

2. Drill a hole to lead the cable through, preferably through the middle of one of the wooden boards.
3. Lead the sensor cable through the drilled hole and attach it to the sensor line according to fig. 10.
4. The cables for the limiter (white) and the temperature sensor (red) are connected to the sensor circuit board acc. Fig. 10. Engage the sensor board into the casing.
5. Lead the sensor cables through the right cable intake into the control unit. Install the sensor cables inside the control unit as shown in Fig. 11. Connect the sensor cables as shown in Fig. 12. In order to do this, pull the plug **X2** from the circuit board and plug it back in after the connection.



Installation of the temperature sensor

1. The temperature sensor should be mounted on the ceiling in the middle of the cabin. See fig. 7 for details.

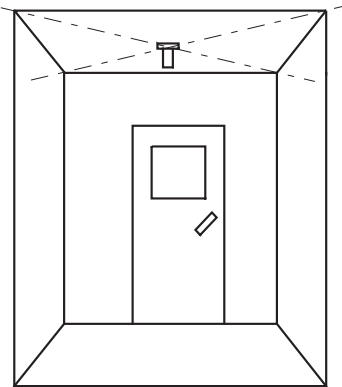

Fig. 7

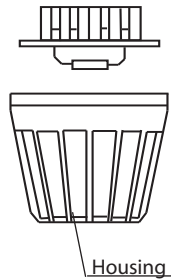

Fig. 8

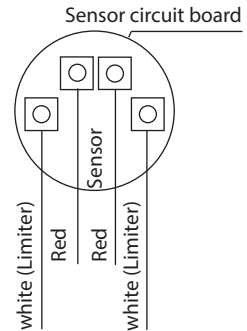

Fig. 9

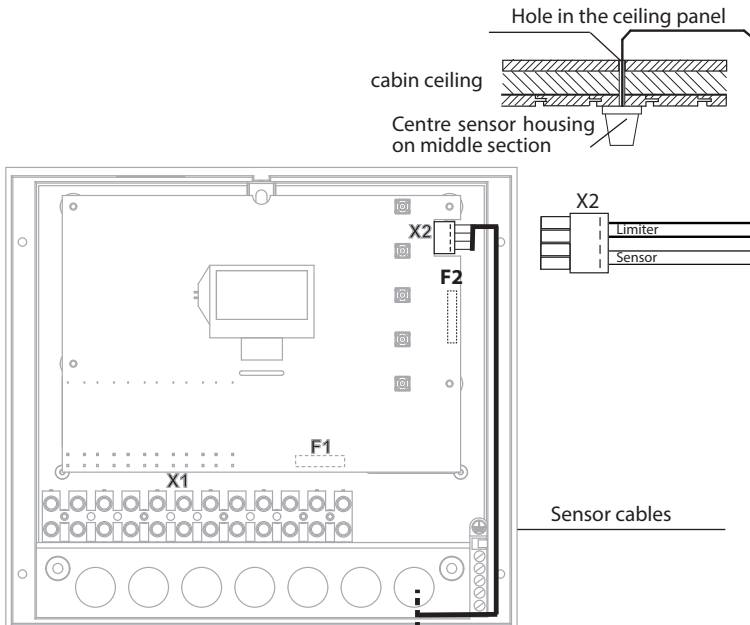

Fig. 10

Attention! Incorrect connection at the connector X2 will cause the fuse F2 to blow (see chapter „Errors“ for replacement advice).

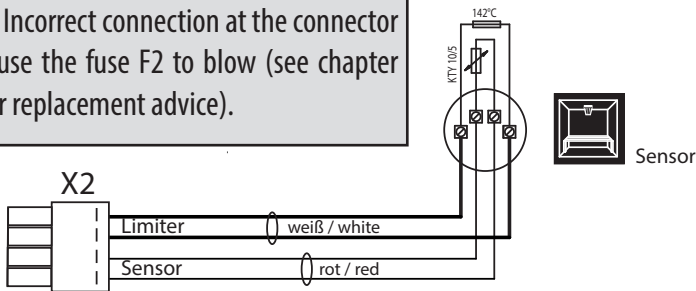

Fig. 11

- After completed installation and correct commissioning of the control unit, the line for overtemperature protection must be checked for short-circuits. In order to do this, disconnect one of the wires of the white cable in the sensor casing. The respective error message appears in the display. Reconnect the wire to make the message disappear.



Electrical connection

The electrical connection may only be done by a certified electrician in compliance with the guidelines of the local utility company and the VDE.

In general, there should be only one permanent connection to the mains. Furthermore equipment should be provided that makes it possible to disconnect the system on all phases from the mains with a contact opening width of minimum 3 mm.

All electrical installations and all connection lines that are installed inside the cabin must be suitable for an ambient temperature of at least 170 °C.

The power supply line is run to the control unit and connected to the power input terminals.



Installation of IR-emitters

- Install the IR-emitters in the cabin as per the appropriate installation manual supplied with the IR-emitters.
- Please pay attention to the maximal power of connected IR-emitters per phase may not exceed 3500 W.



Connecting the cabin lamp

- The cabin lamp must be suitable for the temperatures expected in the infrared cabin.
- Lay the connection cable from the control unit to the lamp through the pre-drilled hole in the cabin wall, so that the cable is not visible inside cabin. Make the connections as per connection diagram and installation guide for the lamp.
- The lamp should be installed as far as possible from the IR-emitters and may not be installed within the direct heat radiation range.

Installation and connection overview

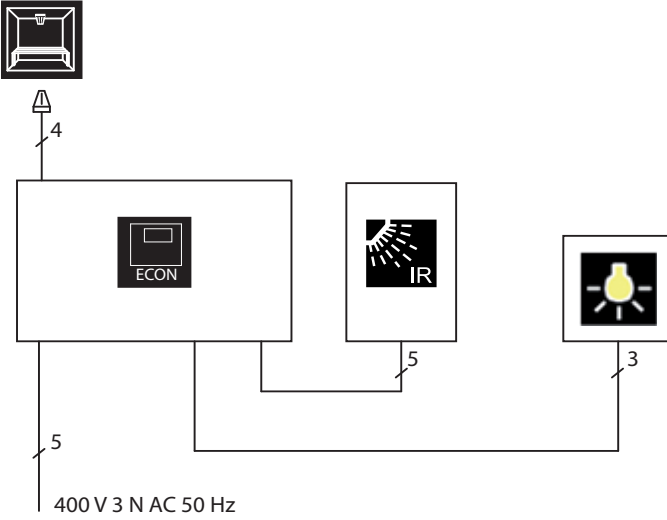

Terminal arrangement on the circuit board.

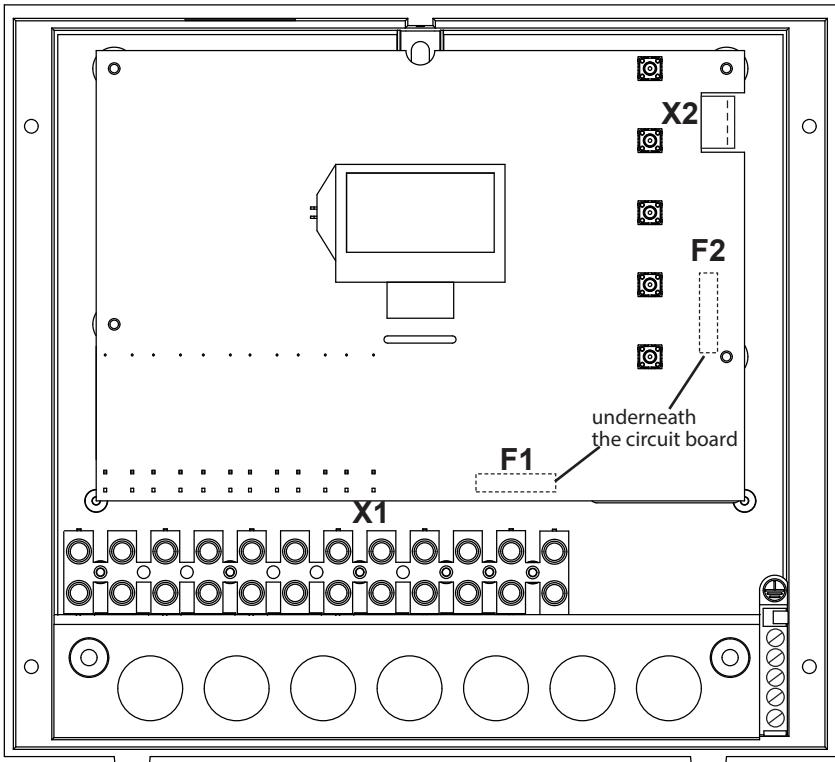

Connection diagram

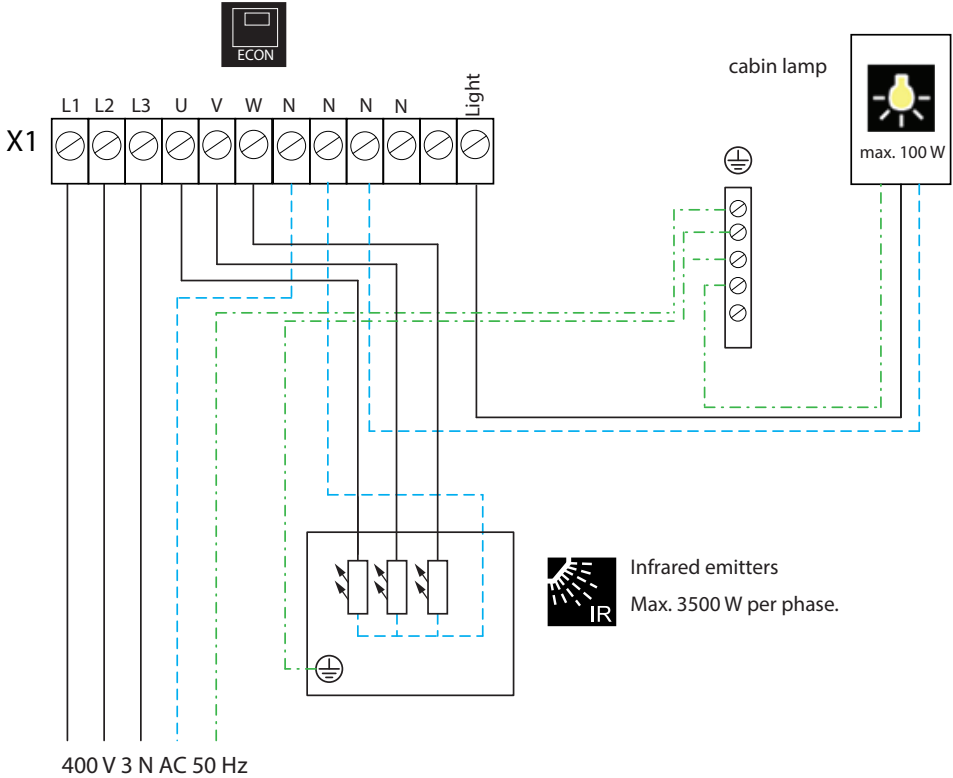

Attention!

If the control unit shall be connected to the single phase power supply, make sure to connect the power supply (phase) to the L1 terminal and the power output to the output terminal W.

The total power load in such case may not exceed 3500 W.

Operation

Once the system has been installed with all components and all covers have been fixed, you can put your IR unit into operation.

Over the following pages we will show you the options provided to you with the control.

General

The user interface

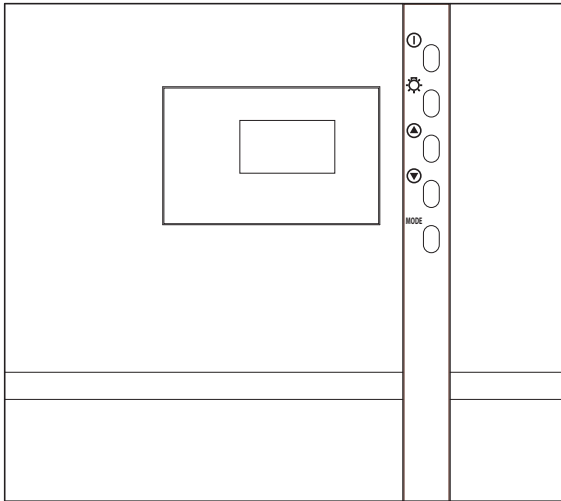



Operating buttons

 = Heating on / off (stand-by mode)

 = Cabin lighting on / off

MODE = Programming mode

 = Increase the value / next function

 = Decrease the value / next function

Default display Stand-by

is shown if the system is in Stand-by mode.

Reset to this display takes place from other menu items if no activity is carried out > 15 s.

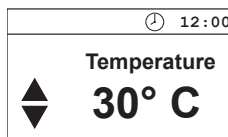

Default display in operation

is shown if the system is in operation. The display switches between the set temperature and the remaining heating time (Auto-Stop).

Reset to this display takes place from other menu items if no activity is carried out > 15 s.

During the heating phase the thermometer fills up on the right side of the display.

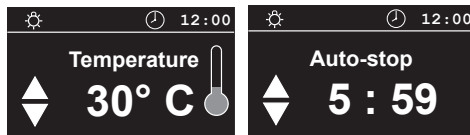

Energy-saving display

If the unit is not used, it will switch into energy-saving mode.

A moving time is shown after 5 minutes, similar to a PC screensaver. The back light for the display is switched off after an additional 15 minutes.

By pressing any key you can return to the Stand-by default display.

The following applies for all settings:

The following is shown in the top area of the display:

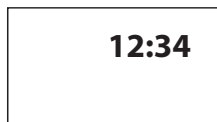

The light - symbol
(when the light is switched on)



The clock symbol

12 : 00

Current time

In addition, the following symbols are displayed depending on the operating mode selected.



Child lock active

Parameters that are highlighted in black on the display can be adjusted.

Parameters that blink on the display can be changed and are shown in these instructions as displayed.

In order to adjust the individual values to the particular desires, briefly push the ▲ or ▼ - buttons to select the desired parameter.

By briefly pushing the **MODE** -button again you will arrive at the programming level.

The name of the parameter is highlighted in black and the modifiable value is now blinking.

The blinking value can then be changed with the ▲ or ▼ - buttons.

All settings out of Stand-by are confirmed by pressing **MODE** > 3 s and are saved in the unit.

The blinking of the parameter ends and the new value is now authoritative until another change is made.

If no key is pressed for > 15 s., the unit switches back into the default display. Changes made up to then are not saved

Cabin lighting

The cabin lighting is automatically switched on as soon as the sauna unit is switched on. In the top left of the display the ☀ - symbol is shown. When the IR unit is switched off the cabin lighting will switch off with a delay of 30 minutes.

Irrespective of the status of the IR unit, the cabin lighting can be ☀ switched on or off any-time with the button.

Temperature

» 30 °C

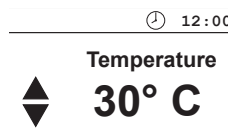

Modifiable parameter

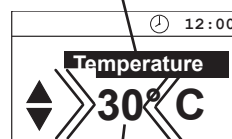

Modifiable value

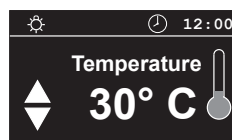
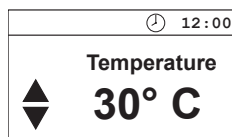

Initial commissioning

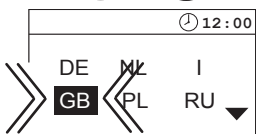
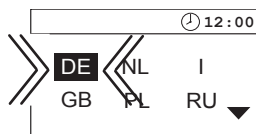

MODE > 3 s

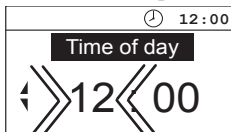
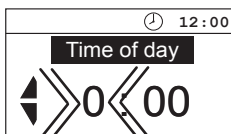

MODE

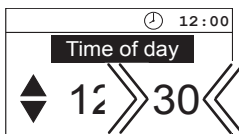
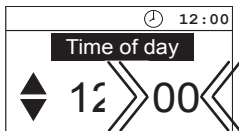

MODE > 3 s

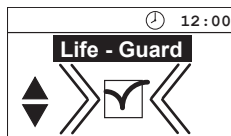
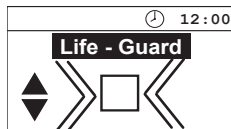

MODE > 3 s

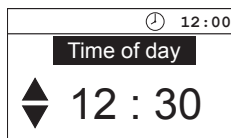

Change language

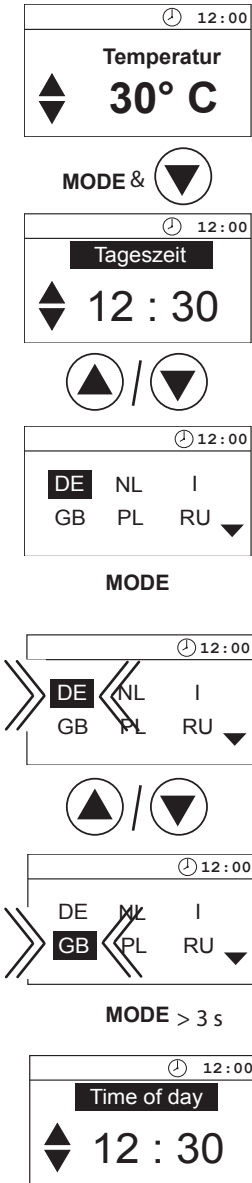

Change time

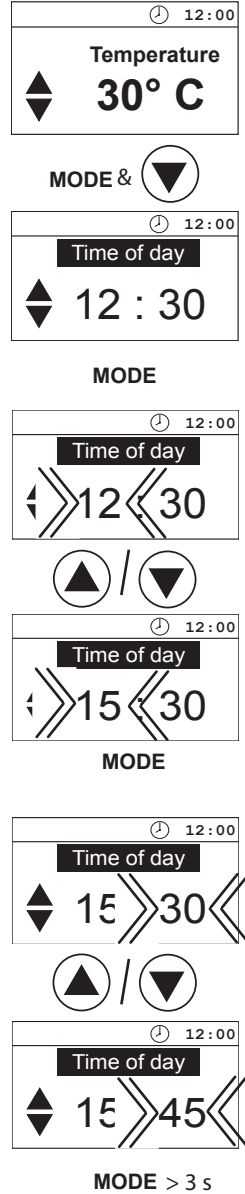

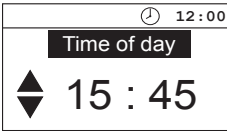

15 s /

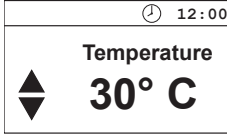

Activating the Life-Guard

Life - Guard is a programmable relatively short time, e.g. 20 minutes after which the IR unit is switched off, except for the cabin lighting. After this time has elapsed the unit can be switched on again by pushing the **MODE** - button for the set time.

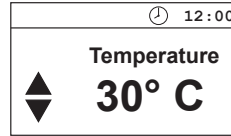

MODE &

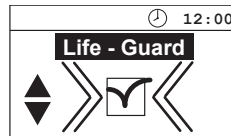
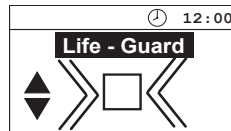

MODE > 3 s

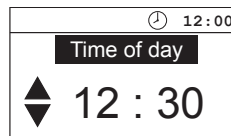

Activate/deactivate the child lock

If the child lock is activated (the key symbol is shown in the top area of the display) only the cabin lighting can be switched. All other buttons are without function. Activating / deactivating the child lock can be done in stand-by as well as in operation. The system can still be switched off in operation.

Activate

Stand-by

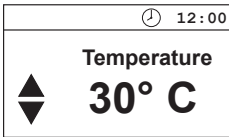

Operation

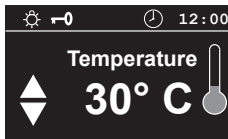
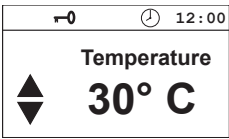
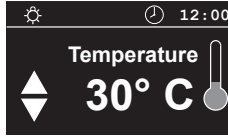

Deactivate

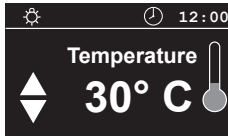
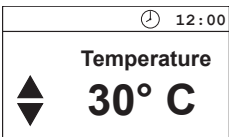
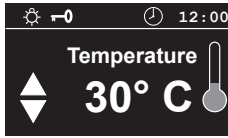
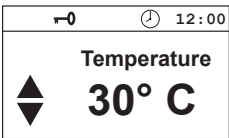

Switching on the IR unit

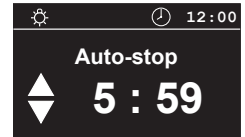
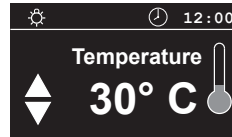
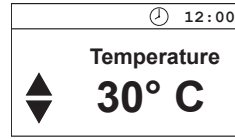

Switching off the sauna unit in the Finnish mode

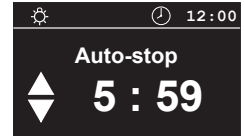
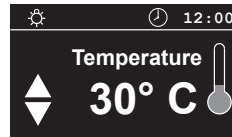

Auto-Stop-Time / 

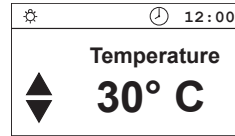

Switching on the IR unit with Life-Guard

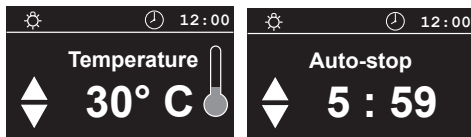
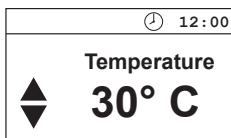

The IR emitter is now heating normally, without "Life-Guard"-time. To activate the function "Life-Guard".

MODE

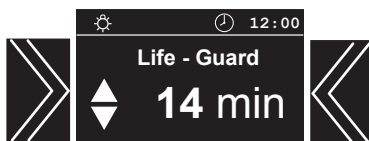

After expiration of the "Life-Guard" - time the IR-emitter is switched off and the set "Life-Guard" - time blinks.



Restart

MODE



or switch off the system

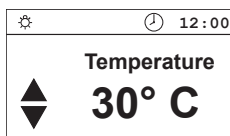

Individual settings

Hereafter we are showing you options that allow you to adjust the controls to your individual needs. The various parameters can be changed in Stand-by or in operation and the changes are saved in the unit. Changes made in operation are effective directly.

Cabin temperature Setting range: Finnish mode 30 - 70°C

In Stand-by

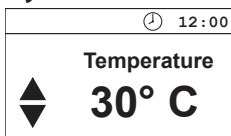

MODE

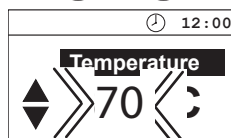
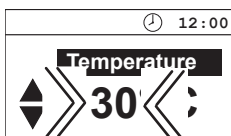

MODE > 3 s

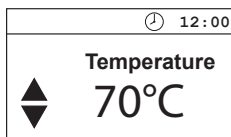

In operation

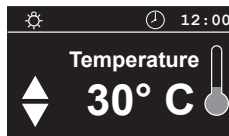

MODE

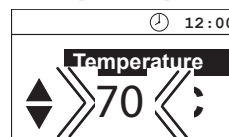
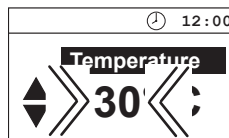

MODE > 3 s

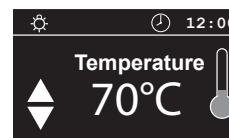

Auto-Stop

Auto-Stop is the time to which the heating time is limited. The IR unit automatically turns off once this time has expired.

The time is adjustable from 0:01 to 6:00 hours.

In Stand-by

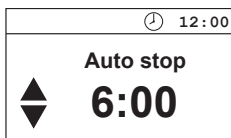
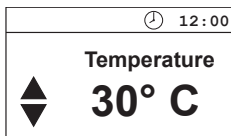

MODE

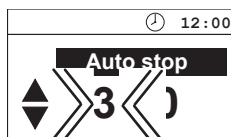
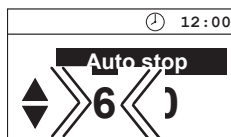

MODE

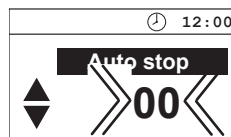

In operation

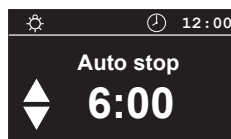
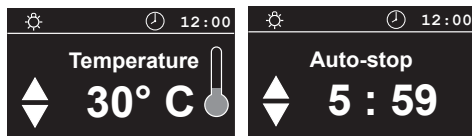

MODE

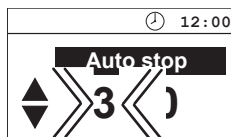
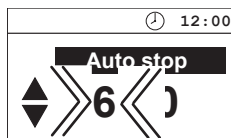

MODE

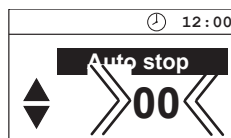

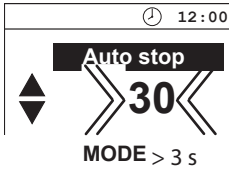

15 s /  > 3 s

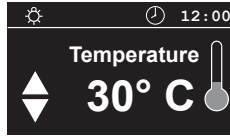
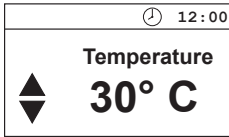
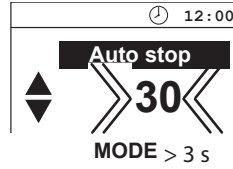

Life - Guard

Here you can set after what time the IR unit is switched off and by pushing the **MODE** - button again you can restart the „Life - Guard“ time.

This setting can only be selected in Stand-by when the function „**Life - Guard**“ is activated.

In Stand-by

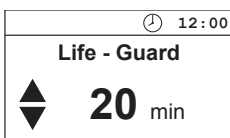
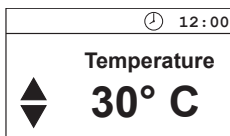

MODE

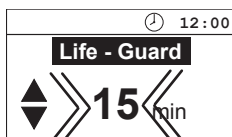
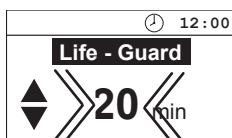

MODE

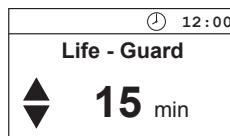

15 s /  > 3 s

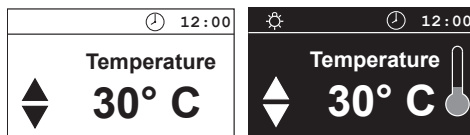

Unit fuses

You will also find 2 micro fuses on the backside of the circuit board

F1 = T 2A Fuse primary electronics and light and fan

F2 = T 250 mA Fuse secondary electronics

Caution! Such work must be left exclusively to an expert. Prior to any kind of work disconnect all poles on the opened control unit from the power supply.

Open the unit as described in the Chapter Installation.

Loosen the four screws on the opened unit that hold the circuit board.

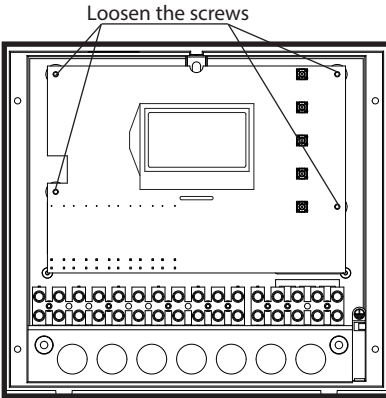

alternative

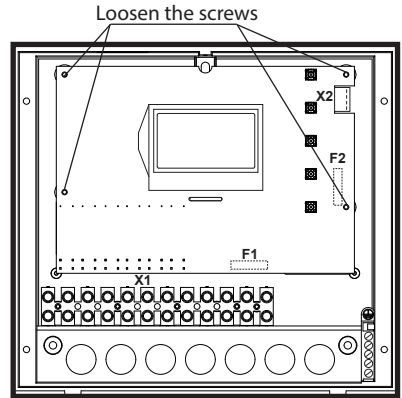

You will find the two fuses on the backside of the circuit board

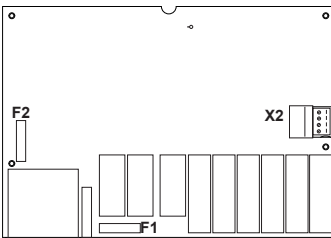

alternative

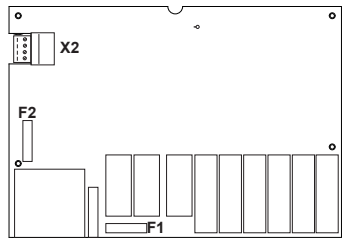

Error messages

The control unit continuously monitors the sensor for short circuits and interruptions. The error messages appear as follows:

Display

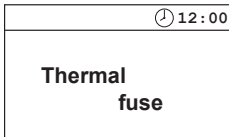
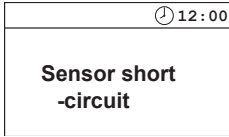
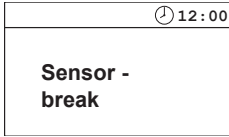

Cause

= Interruption in the room sensor circuit

The temperature sensor (KTY) is defective or the line to the temperature sensor is interrupted.

= Short-circuit in the room sensor circuit

The temperature sensor (KTY) is defective, or the line to the temperature sensor is short-circuited.

= Interruption in the limiter circuit

The thermal fuse (142°C) has tripped or the line to the thermal fuse is interrupted.

Remedy

Have cables and KTY checked by an expert.

KTY at 20°C approx. 2 kΩ may have to be replaced.

Have cables and KTY checked by an expert.

Have cables and thermal fuses checked by an expert.

The device „Switch-off“ switch

You will find the rocker switch on the top side of the control unit. You can completely disconnect the control unit from the mains using this switch.

Switch-off by ECON control units

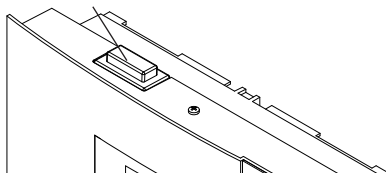

Switch-off

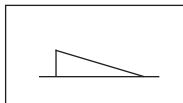

Unit turned on
(default Position I)

Press the switch on the left side of the rocker to the first latch (**switch setting 0**). The switch will be in the middle position. The unit is now completely switched off (disconnected).

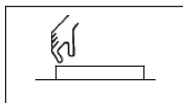

Unit fully switched off
Position 0.

To turn the light on in the cabin while the unit is still disconnected push the left side of the rocker to the second latch (**switch setting II**).

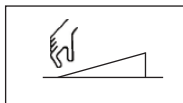

Light switched on;
Unit switched off.
Position II.

To make the unit ready for operation, switch back to the initial position (**switch setting I**). The unit will return to stand-by mode.

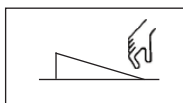

Unit switched on.
Position I.

Please keep this address in a safe place together with the installation guide.

To help us answer your questions quickly and competently please provide the information printed on the type shield including the model, item no. and serial no., in all inquiries.

Service Address:

EOS Saunatechnik GmbH
Schneiderstriesch 1

35759 Driedorf, Germany

Tel: +49 (0)2775 82-514

Fax: +49 (0)2775 82-431

servicecenter@eos-sauna.de

www.eos-sauna.de

WARRANTY

The warranty is provided according to the legal regulations at present.

Manufacturer's guarantee:

- The period of guarantee starts from the date of purchase and lasts up to 2 years by commercial use and 3 years by private use.
- Always include the completed guarantee certificate when returning equipment.
- The guarantee is void for appliances which have been modified without manufacturer's explicit agreement.
- Damages caused by incorrect operation or handling through non-authorized persons are not covered under the terms of guarantee.
- In the event of a claim please indicate the serial number as well as the item number and model name with detailed description of the fault.
- This guarantee covers defective parts and labour but not the defects caused by wear and tear.

In case of complaint please return the equipment in its original packaging or other suitable packaging (caution: danger of transport damage) to our service department.

Always include the completed warranty certificate when returning equipment.

Possible shipping costs arising from the transport to and from point of repair cannot be overtaken by us.

Outside of Germany please contact your specialist dealer in case of warranty claims. Direct warranty processing with our service department is in this case not possible.

Equipment commissioning date:

Stamp and signature of the authorized electrician:

Handling procedures for return shipments (RMA) - Details for all returns !

Dear customer

we hope that you will be satisfied with the purchased EOS product. In the rear case if you may have a claim and will need to return a product, please follow the procedures specified below. This will enable to ensure a quick and effective handling of the return shipment.

Please observe for all returns!

- Please add the provided **RMA-voucher completely filled out** together with an **invoice copy** to the return shipment! Do not stick it on the goods or on the packaging. **We do not accept return shipments without these papers.**
- Not prepaid parcels **will be refused** and returned to Sender! Please always ask your dealer or EOS service department about the most economical return shipment way.
- **Please pay attention that** the goods have to be sent back in the **original scope of delivery** and in **original packing**.
- We recommend to use an **additional solid and break-proof covering box** which should be padded out with styrofoam, paper or similar. Transport damages as a result of faulty packing are for the sender's account.

Reason of complaint and proceedings:

1) Transportation damage

- Please check the content of your parcel immediately and advise the forwarding company of a claim (parcel service/freight forwarder)
- Do not use damaged goods!
- Ask the forwarder **for a written acknowledgement of the damages.**
- **Report the claim promptly by phone to your dealer.** He will discuss with you how to act in this case.
- If the transport box has been damaged, please use an additional covering box. Do not forget to add the **acknowledgement of the damage of the forwarding company!**

2) Faulty goods

- The implied warranty period is 2 years. Please contact your dealer in case of **faulty or wrong articles or missing accessories.** He will discuss with you the individual case and try for immediate and customer-friendly solution.
- For **economic returns** within Germany you will get an **RMA-number from the manufacturer.**
- All returns have to be in the **original packing of the goods with corresponding accessories.** Please repack the goods to avoid damages. In case of wrong delivery, please do not use this article .

3) Problems of installation and functioning

- Please **read the manual carefully first of all** and pay attention to the indicated assembly or installing instructions.
- **Your dealer should be the first contact person** because he knows his products best and also knows possible problems.
- **In case of function problems with an article,** please check at first whether there is an obvious material defect. The quality system in our factory reduces malfunctions of new appliances to almost zero.