



MANUAL

COZY TANK

SAUNA ROOM HUMIDIFIER

HP01-071	1,3 Liters	240 x 60 x 210mm	Taurus, Mini, Mini X, Scandia, Savonia, Nordex Mini, Nordex, Nordex Floor, Nimbus, Cumulus
----------	------------	------------------	--

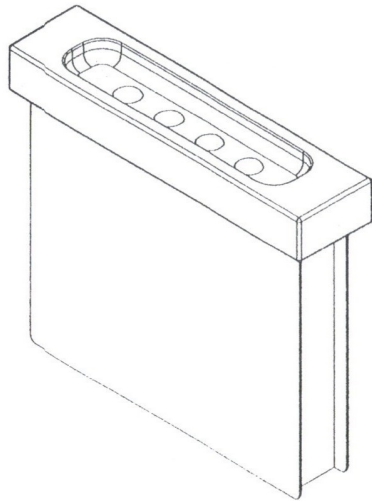

RECTANGULAR

Cozy tanks are kept with water with the heater to increase humidity inside the sauna room.

- 1 Remove the stones on top of the heater enough for the cozy tank to sit in.
- 2 Insert the cozy tank container in between the heating elements. Make sure to level it with stones. (See Fig. 1)

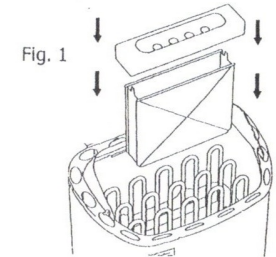

- 3 Insert the cozy tank cover. (See Fig. 2)

Fig. 2

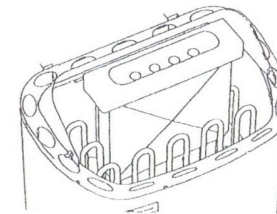

- 4 Add stones on the sides the cozy tank. (See Fig. 3)

Fig. 3

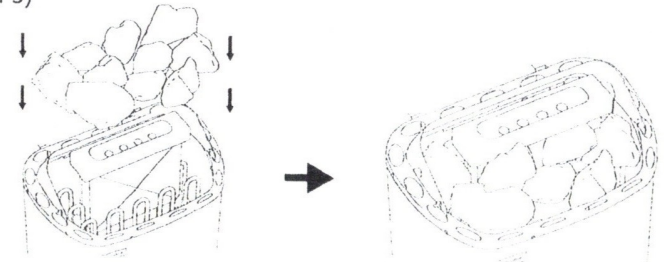

- 5 Fill with water the cozy tank before or during sauna to increase humidity. (See Fig. 4)

Fig. 4

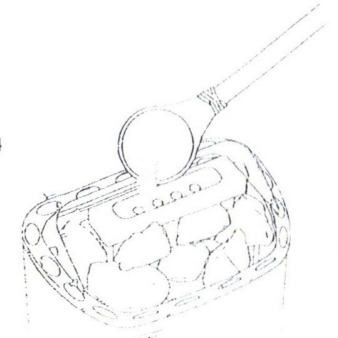

WARNING!
Before turning ON the heater, be sure that the Cozy Tank is filled with water and never leave it empty.



MANUAL

COZY TANK

SAUNA ROOM HUMIDIFIER

CODE	WATER VOLUME	SIZE	BEST PAIRED WITH THESE HEATERS:
HP01-070	0,6 Liters	110 x 110 x 200mm	Tower (Round, Wall, Corner), Aries (Round, Wall, Corner), Phoenix, Orion, Cubos

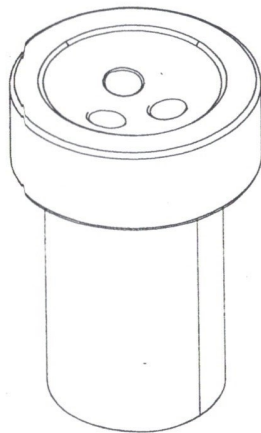

CYLINDRICAL

Cozy tanks are kept with water with the heater to increase humidity inside the sauna room.

- 1 Remove the stones on top of the heater enough for the cozy tank to sit in.
- 2 Insert the cozy tank container in between the heating elements. Make sure to level it with stones. (See Fig. 1)

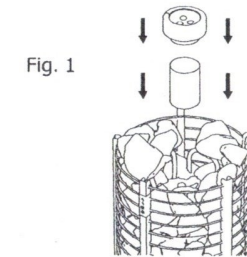

- 3 Insert the cozy tank cover. (See Fig. 2)

Fig. 2

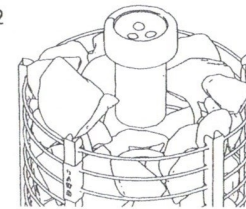

- 4 Add stones on the sides the cozy tank. (See Fig. 3)

Fig. 3

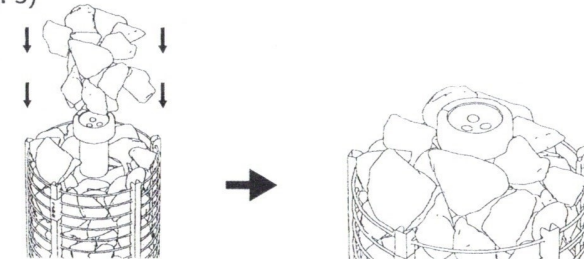

- 5 Fill with water the cozy tank before or during sauna to increase humidity. (See Fig. 4)

Fig. 4

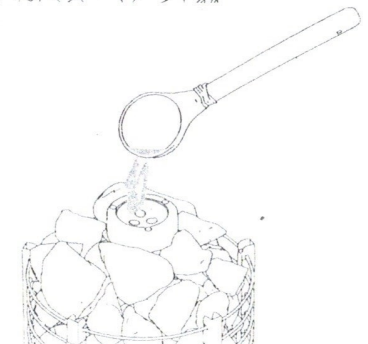

WARNING!

Before turning ON the heater, be sure that the Cozy Tank is filled with water and never leave it empty.