

EmoStyle Di EmoStyle Hi

sauna control unit



Installation and operation manual

Made in Germany

 **CE EAC IPx4**

Firmware R3.50

Print no. 29344816 en / 34.19
Technical changes reserved

English

Contents

Preface and general information about sauna bathing	4
General safety precautions	5-6
Scope of delivery	7
Accessories	7
Technical data.....	8-9
Intended use	9
Installation	10-17
Main electronic unit.....	10-11
Control panel - location and cable connection	12
Control panel - voltage regulator	13
Control panel - flush-mounted installation.....	14-15
Installation of the temperatur sensor.....	16-17
Electrical connection.....	18-22
Sauna heater connection.....	18
Sauna lamp connection	19
Connection of the power extension unit.....	19
Installation diagram and terminal layout	20-21
Temperature sensor	22
Humidity sensor	22
2nd temperature sensor (bench sensor).....	22
Overview - connection scheme (Emotec D/H, EmoStyle D/Di and H/Hi)	23
Humidity sensor installation	24
Vaporizer connection.....	25
Installation of the optional bench sensor.....	26
Setup (commissioning / first switching)	27-28
Operation	29-40
Overview.....	29
Symbol description (main navigation menu).....	30
Graphic user interface	31
Operation and program settings	32-36
Symbol description (extended settings).....	37
Extended settings.....	38-40

Manual setting of the lamp	41
Service	42-46
Service- and Setup	42
Symbol description	43
Settings	44-46
Troubleshooting (error messages)	47
The "switch-off" rocker switch	48
Recycling	49
Service Address	49
General Terms and Conditions of Service	50

Preface

Dear customer,
you have purchased a high-quality electronic device with which you will enjoy your sauna for many years to come. This sauna control unit was designed and inspected according to the current European safety standards and manufactured at the factory in accordance with the quality management standard DIN EN ISO 9001:2015.

This detailed installation and operation manual has been prepared for your information. Pay particular attention to the **important notes** and the information on electrical connection.

We wish you a restorative and eventful sauna bathing experience.

General information about sauna bathing

Please note that an optimal interaction between sauna cabin, sauna heater and sauna control unit is mandatory for a pleasant sauna climate in your cabin. With this high-quality sauna control unit you can “operate” your sauna system, and thanks to the many individual programming options, surely you will quickly find the setting which suits you best.

Perception in the sauna is very subjective, therefore, it really requires your own perception or that of your family to find the most suitable settings.

The control units are supplied with the preset typical climate values for a classic Finnish sauna or for models with humidity control, as well as for a sauna with humidity operation.

The following operating instructions describe how to pre-select “your” climate in the cabin. Read these instructions carefully, so that you

quickly and easily find your way through the programming process. Please note the variation in temperatures in the cabin while sauna bathing. The hottest area is directly below the cabin ceiling, whereas there is a steady temperature gradient towards the floor of the cabin. Inversely, the relative humidity is lowest directly below the cabin ceiling and the highest by the cabin floor.

For safety reasons the temperature sensor with the overheat safety shutdown is located on the cabin ceiling above the heater, as this is usually the hottest area in the cabin.

Thus, there will always be temperature variations between the temperature sensor of the control unit and the thermometer in the cabin.



For example, when pre-setting the cabin temperature to 100 °C, the thermometer inside the cabin may show 85 °C - 90 °C. This is in accordance with the typical climate inside the cabin.

Only use sauna-suitable (up to 140 °C temperature-resistant) cabin lights. Always pay attention to hygiene. Always use hand- or bathing towels to avoid getting perspiration on the wood.

For control units with vaporizer connection (optional), we recommend to reheat or dry the cabin after each humid operation, in order to protect your cabin from possible damage due to the humidity mode. In addition, in poorly ventilated rooms, a ventilation fan can be used to remove the used moist air.

To avoid drafts, you should avoid using any ventilation system while sauna bathing. It should only be used if recommended by the cabin manufacturer.

General safety precautions

- This device may be used by children (age 8 and above) and by persons with reduced physical, sensory, or mental disabilities, or inadequate experience and knowledge, if they are supervised or if they have received adequate instructions in how to use the device safely and understand the associated risks. Children may not play with this device. Children may not clean or carry out any user maintenance if unsupervised.
- Children are to be supervised, in order to make sure that they do not play with this device.
-  **ATTENTION:** It is forbidden to install the control box in a closed switch cabinet or behind a wooden panelling!
- The electrical installation may only be done by a qualified electrical technician.
- You must comply with the regulations of your power supply company and applicable VDE regulations (DIN VDE 0100).
-  **WARNING:** Never attempt repairs or installations yourself, as this could result in serious injury or death. Only a qualified technician may remove the housing cover.
- Please note the dimensions in the installation instructions, especially when installing the temperature sensor. The temperature above the heater is critical for the

temperature setting. The temperature can be held within operating parameters and a minimal deviation at the bench level of the sauna cabin can be achieved only if the device is installed correctly.

- The device may only be used as intended as a control unit for sauna heaters up to 9 kW (up to 36 kW when combined with a power extension unit).
- Completely disconnect the control unit from the electrical circuit, i.e. flip all circuit breakers or the main circuit breaker during each installation or repair.
- Please note the safety and installation information from the sauna heater manufacturer.
- Make sure to observe the specifications and instructions of the sauna cabin manufacturer.

 **ATTENTION:** For control units with remote control functions*, a protection against switching on if the heater is covered is required. (e.g. cover protection rail type 1-5).

**Remote control = setting up, controlling or adjusting a unit by a command that can be given out of view of the unit by means of transfer media such as telecommunication, audio technology or bus systems, this also includes weekly timers. (from EN 60335-1)*

 When designing the sauna cabin, ensure that the external exposed glass surfaces may only reach a maximum temperature of 76 °C. If necessary, protective features need to be fitted.

 Inspect the sauna cabin before each use! In particular, ensure that no objects have been stored on the sauna heater or the IR-radiator, if applicable.

Risk of fire!

 **Attention!**

Dear customer,
according to the valid regulations, the electrical connection of the sauna heater and the control box has to be carried out through the specialist of an authorized electric shop

We would like to draw your attention that in case of a warranty claim, you are kindly requested to present a copy of the invoice of the executive electric shop.

 **Attention!**

Only the original spare parts may be used.
Any modification of the cables included in the delivery can lead to malfunctions and is not permitted.

Any unauthorized technical alteration makes the product warranty void.

Scope of delivery

Check the device for completeness upon receipt. The delivery includes:

1. Main electronic unit (with two-part front cover)
2. Control panel with colour display
3. Voltage regulator
4. Housing base for flush-mounted installation of the control panel
5. De-installation tool (for control panel)
6. Temperature sensor: a) housing, b) sensor board, c) overheat protection fuse, d) 2 mounting screws 4 x 40 mm, e) connection cable 5 m with RJ10 plug, f) 2-core white cable for overheating protection fuse 5 m
7. Connection cable (control panel - main block) with RJ14 / RJ10 plugs
8. 1 spare overheating protection fuse
9. Plastic bag with 3 mounting screws 4 x 25 mm (for main electronic unit)
10. 8 rubber cable glands
11. 1 installation and operation manual, 1 operation manual (for end users)

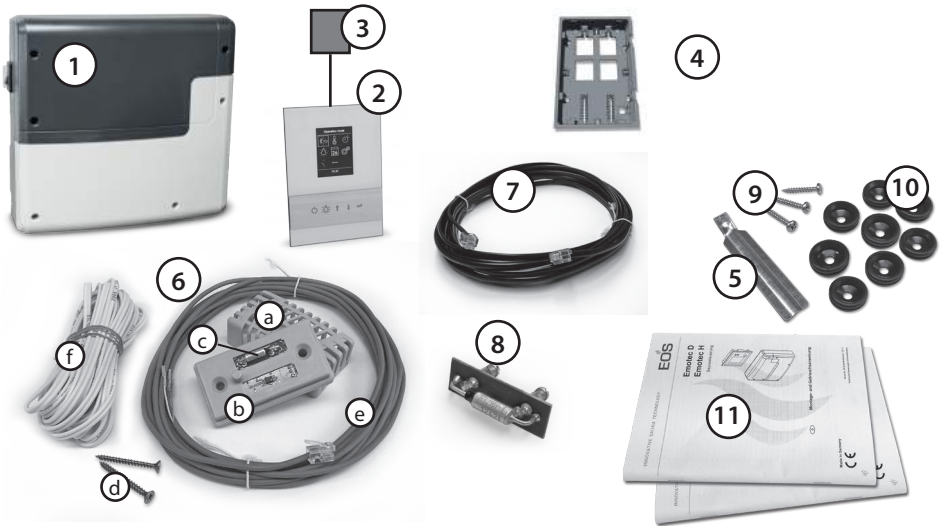

Accessories (optionally available):

2 nd sensor	Item no. 94.5725	KNX-/Modbus-module	Item no. 94.7078 / 94.7077
Humidity sensor	Item no. 94.5726 (only H-model)	SBM-HOT	Item no. 94.6800
Coloured light control module...	Item no. 94.5996, 94.6007	SBM-ECO	Item no. 94.6980
Sound module.....	Item no. 94.5920, 94.5921		
Remote start modul	Item no. 94.5782		
SBM-WCI-01 web app module ..	Item no. 94.5987		

Technical data

Voltage (power supply):	400 V 3 N AC 50 Hz
Switching capacity:	max. 9 kW resistive load, may be extended with a power extension unit (LSG)
Fuse	3 x 16 A
Heating time limit:	6 h / 12 h / unlimited
Housing:	plastic, shatter-resistant
Display:	TTFT colour display 55 x 74 mm (3,5" size)
Operation:	5 capacitive buttons on the control panel
Protection type:	IPx4 in accordance with EN 60529, splashproof
Temperature control range:	30° - 115°C (dry sauna mode) 30° - 70°C (humid sauna mode - only H series models)
Humidity control:	proportional to time or optionally as per rel. air humidity (%) with an optional humidity sensor.
Sensor system:	Digital sensor with overheating protection fuse (STB) 139°C
Control characteristic:	Digital two-point control
Connection for fan:	min. 5 W, max.150 W (only fans without starting capacitor) Only use fans suitable for phase control!
Connection for light:	<ul style="list-style-type: none"> • min. 5 W (20 mA) • resistive loads - max. 100 W, • dimmable energy saving lamps - max. 35 W • Lamps at conventional transformers - max. 60 VA. <p>Attention: only dimmable lamps may be used!</p> <p> Fan and light output share a common 2AF fuse.</p>
Volt-free output:	contact's resistive load carrying capacity: maximum current: 16 A maximum voltage: 30 V DC / 250VAC
Start time pre-selection:	up to 24 h in advance
Switching automation:	Week timer with 4 switching programs per day
Error display:	Clear text error indication on the display
Outputs:	3 x RJ10 jacks for sensor connections 2 x RJ14 jacks for control panel and extension modules 1 x potential free contact (2 terminals)
Output S1:	maximal load 50 W / 50 VA, no capacitive loads allowed.
Terminal block area for power supply and heater connection:	0.5 – 2.5 mm ² rigid or flexible crimped wire, two cores with the same cross section per terminal may be connected
Terminal block area WM, 3, 4, light, fan:	0.34 – 2.5 mm ² rigid or flexible crimped wire. Please observe the minimal cross section as per fuse protection of the line!

Card reader:	Micro-SD card reader in control panel
Ambient temperatures:	-10°C bis +35°C
Storage temperatures:	-20°C bis +60°C
Place of installation requirement:	Intended for indoor installation only. Sensors - may not be installed in corrosive or highly salty environment. Device - may not be installed in corrosive environment or in an environment which may cause water condensation.
Dimensions main block:	H 270 x W 300 x D 100 mm
Dimensions control panel:	H 202 x W 142 x D 42 mm (flush-mounting) recessed part 37 mm deep

Important note!



The control unit is not suitable for outdoor use!

It may only be used inside buildings and may not be exposed to environmental conditions such as extreme humidity or moisture with possible condensate formation or corrosive substances in the ambient air and other weathering. Excessive exposure to cold and intense solar radiation should be avoided as well. If there is an increased risk of mechanical damage, the control unit must be protected accordingly.

Intended use

This sauna control unit is exclusively intended for the control of the sauna heater in a sauna cabin. Any other use over and above the intended purpose is not considered as appropriate use! Compliance of the standard operation, maintenance and repair conditions is also an element of appropriate use.

The manufacturer cannot be held liable for

deviating, unauthorized alterations and any resulting damages; the initiator of these changes bears the full risk.

Installation of the main electronic unit

The main electronic unit (relay box) may be installed only outside the sauna cabin. The recommended places of installation are the outer sauna wall or the engineering room (plant room). If empty ducts for connection cables are already available, then they usually predetermine the installation position. The installation shall be carried out as follows:

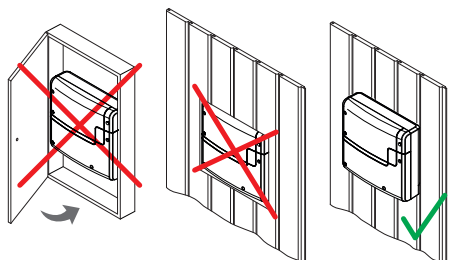

⚠ Attention: The relay box may not be installed in a closed switch cabinet or behind a wooden panelling!
Risk of overheating! Fire hazard!

1. Remove the lower cover from the relay box. Unscrew the 3 fixation screws, then slightly pull the lower housing cover down and take it off. See Fig. 1 for details.

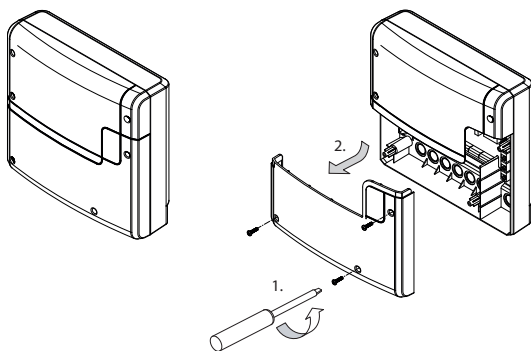

Fig. 1

The holes for the provided 4 x 25 mm screws are to be installed according to the dimensions shown in Fig. 2.

2. Use the upper central screw to hang the relay box. Make sure that this screw stands out approx. 3 mm (detail in Fig. 2).

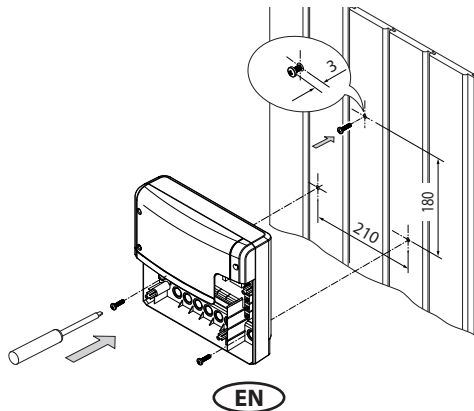

Fig. 2

3. Hang the housing on the upper central screw in the upper central mounting hole.
Insert the supplied rubber cable glands into the openings of the bottom of the housing (from below or from behind, as desired) and then guide the connection cables through these openings.
Screw the lower part of the housing firmly to the cabin wall in the two lower mounting holes (Fig. 3).

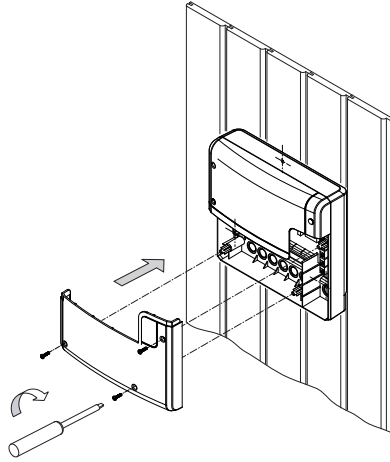

Fig. 3

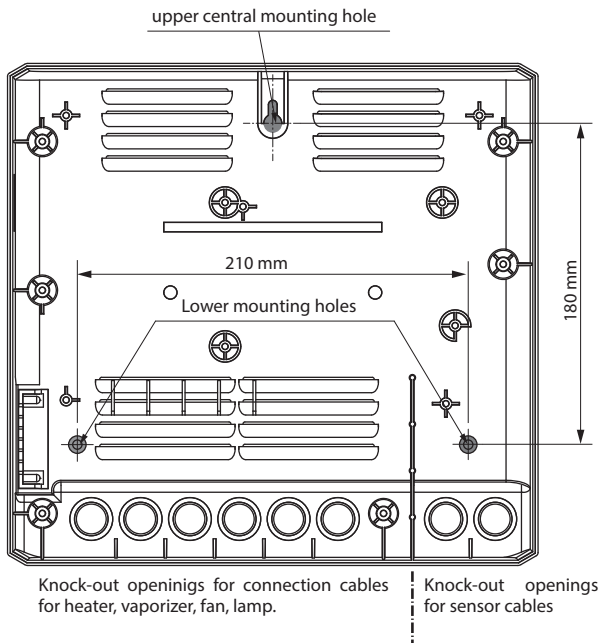

Fig. 4

Control panel

Location

The control panel may be mounted inside the sauna cabin on the sauna wall. If ductwork is already provided for electrical installations then the position of the control panel is predetermined by that.

The control panel is designed for flush-mounted installation into the sauna wall. The installation shall be carried out as follows.

First of all determine the location.

Make an installation cut-out in the wall with the size 189 mm height x 128 mm depth (fig. 5).

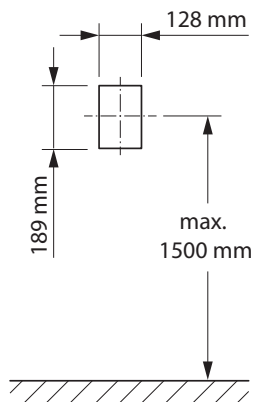

Fig. 5

Cable connection

Lay the connection cable from the relay box to the control panel.

The connection cable may be laid only between the outer sauna wall and insulation layer to prevent overheating (fig. 6).

The insulation should ensure that the temperature at the outer sauna wall may not exceed 65 °C.

Make sure that the cable with the smaller plug (RJ10) is routed to the control panel.

Use the supplied 5 m connection cable with RJ10 plug (control panel side) and RJ14 plug (relay box side).

If necessary, this connection line may be extended to approx. 100 m length. The extension should occur on the relay box side. For this purpose, a coupling (RJ14 / RJ14) and an extension cable with RJ14 connector are required (available from specialist dealers).



Important notice:

Maximum cable length between control panel and main unit is 100 m.

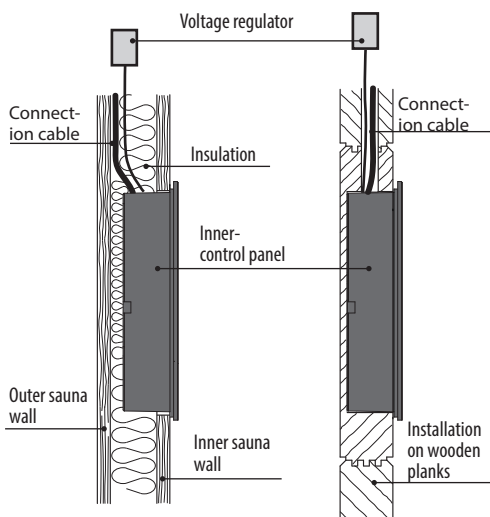

Fig. 6

Voltage regulator

The control panel is equipped with an external voltage regulator. This component is located in a small separate metal housing and is connected to the control panel by cable.

The voltage regulator may be placed e.g. on the sauna roof. Guide the connection cable of the voltage regulator to the control panel and insert the plug into the corresponding small socket on the circuit board before inserting the control panel into the lower part (see fig. 7).

The voltage regulator must not be exposed to elevated temperatures. Therefore, the installation in the sauna wall is not permitted. The voltage regulator may be placed e.g. on the sauna roof.

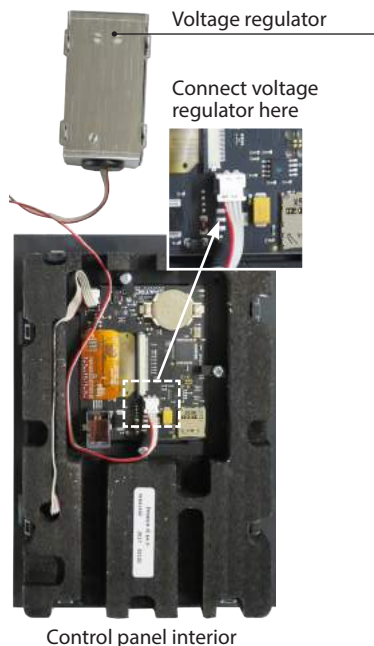
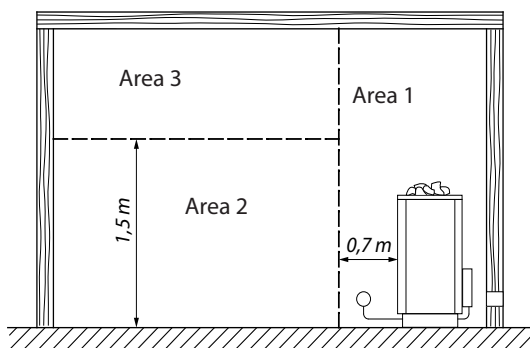

Fig. 7

Notes on mounting the control panel in sauna cabins

Can be used in sauna cabins in areas up to 110 °C (area 2).

Never directly above or in the surrounding area of the sauna heater (area 1), or in the direct radiation range of short-wave infrared radiators.



ATTENTION!

When installing the control panel, ensure the tightness in the inside of the cabin. Excessively high temperatures inside the control panel can lead to errors with the electronic components.

Flush-mounted installation (wall-mounting)

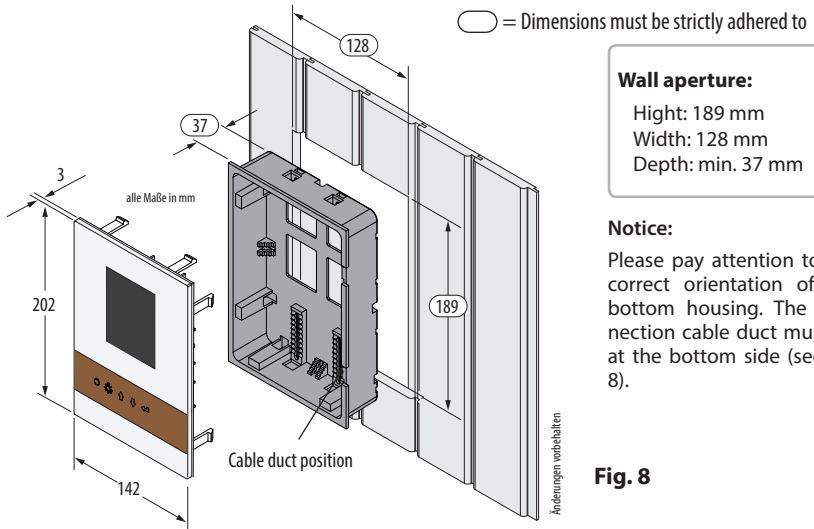

Fig. 8

Installation of the housing base

First install the housing base (see fig. 8).

1. Loosen 4 screws on the fastening brackets
2. Pull the connection cable and the voltage regulator cable through the cable duct in the housing base.
3. Insert the housing base into the wall opening.
4. Adjust the brackets by moving them on the fastening brackets of the housing part to the designated wall panelling thickness.
5. Clamp the brackets (by tightening the screw clockwise)

Minimum wall depth:
37 mm

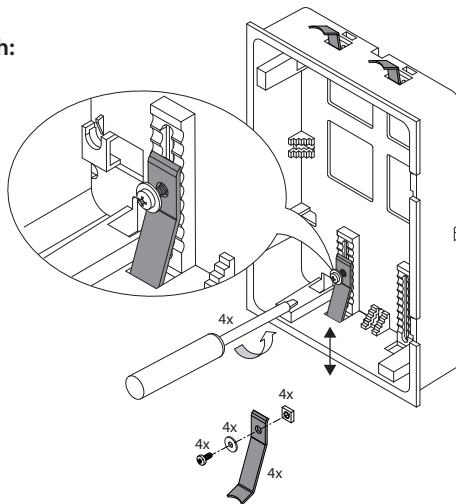

Fig. 9

Installation of the housing upper part (control panel with display)

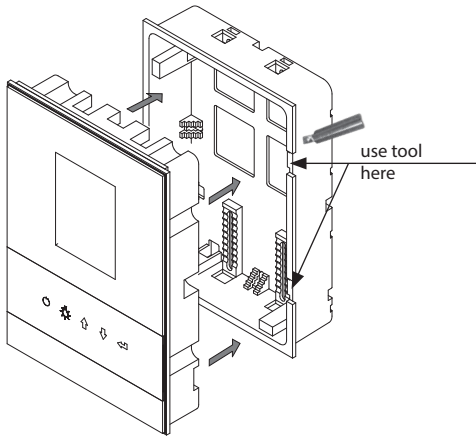
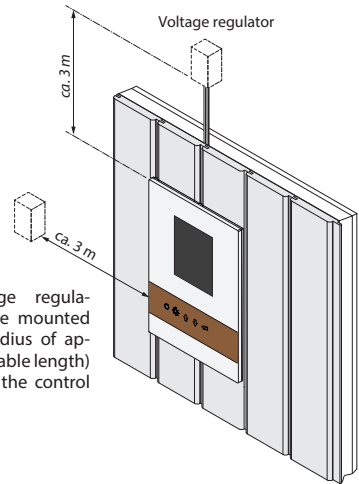

Fig. 10



The voltage regulator must be mounted within a radius of approx. 3 m (cable length) away from the control panel.

Fig. 11

Place the control panel directly in front of the housing base and pay attention to the correct orientation. Plug in the connection cable with the RJ10 plug to the control panel. Now press the control panel carefully into the housing base until the fastening tabs lock securely. Make sure the control panel sits reliably in the base part.

Notice: When you lay the connection cable do not pull it too tight, allow some extra length around the base, so that later you can easily take the control panel out of the base while still having it connected.

How to remove the display panel

In order to remove the display panel, use the included removal tool or a similar suitable tool like a flat headed screwdriver.

Insert the two tools into the grooves on the side edge of the control panel (between control panel and wall housing) and lever the control panel from the wall surface, then pull it out of the wall housing. Make sure that the connection cable can also be removed from the wall housing.

Remove the connection cable from the RJ-plug on the control panel. For this purpose, carefully press on the small securing tab of the plug and pull it out of the connector.



Important note:

For the removal, use the tools exclusively for the provided grooves in the control panel. Under no circumstances may the tools be used elsewhere! This can damage the glass of the control panel. In this case, the warranty is void!

Connection of sensor cables

Do not lay sensor and power supply lines together, or lead them through the same duct. This can lead to interferences in the electronics, such as “fluttering” in the relays. Connect the cable shielding (if present) to ground in the control unit.

Please observe that the following dimensions relate to the values stipulated during the unit inspection acc. EN 60335-2-53. The heater sensor must always be installed at the point where the highest temperatures are to be expected. Fig. 12-14 provide you an overview of the mounting point of the sensor.



Installation of the temperature sensor

Make sure that there is no deviating mounting position of the sensor, specific to the sauna heater (check the installation guide of the sauna heater).

1. Mount the heater sensor in cabins up to 2 x 2 m according to fig. 13, in larger cabins according to fig. 14.
2. Drill a hole to lead the cable through, preferably through the middle of one of the wooden planks.

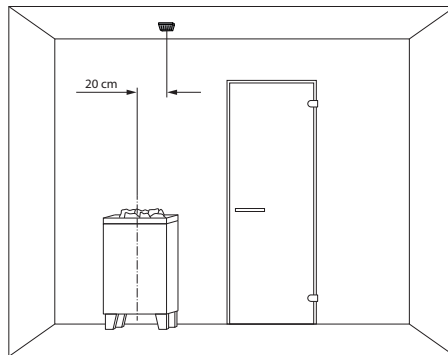

Fig. 12

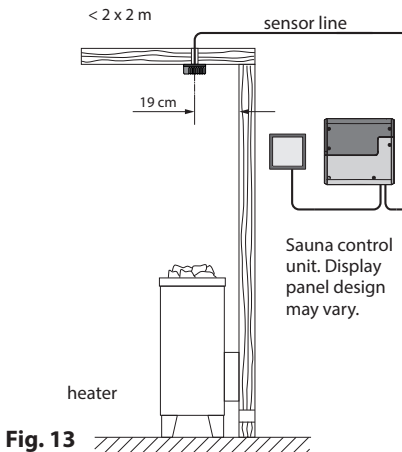

Fig. 13

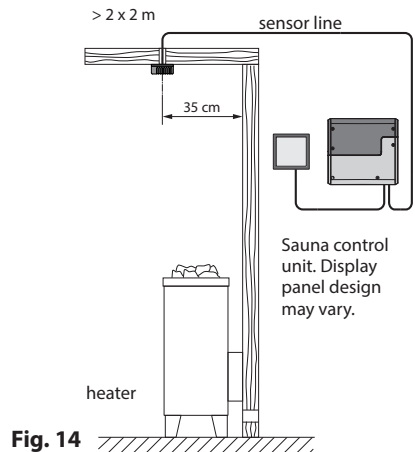
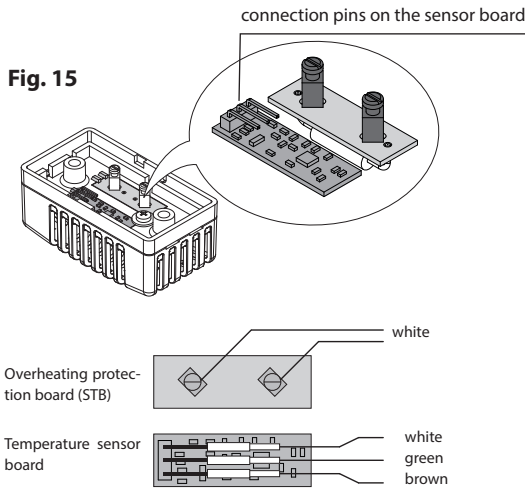

Fig. 14

3. Lead the sensor cable (red) and the limiter cable (white) through the drilled hole and connect both cables to the main relay box.
4. Connect the sensor cable to the sensor board according to fig.15. Make sure the connections are correct. Connect the limiter cable (2-core white cable) to the limiter board (STB).
5. Mount the sensor to the ceiling plank using two supplied screws and attach the housing cover.
6. After completed installation and correct commissioning of the control unit, the sensor line for overheating protection must be tested for proper functioning. Disconnect one of the wires of the white cable at the STB board in the sensor housing - the respective error message shall appear on the display. Re-connect the wire to make the error message disappear.

Temperature sensor - connections:



⚠ Attention:

Please pay attention that during the installation of cable lines for sensors and the display panel, it is not permitted to pull the cable by the modular plug. If you draw the cable through the ducts, it must not be attached to the plug, but to the cable only!

Pulling the cable by the plug may damage it and cause loose contacts resulting in malfunction of the control unit. In such case the warranty will be void and the cable should be replaced.

Make sure to observe the correct wire connection order on the temperature sensor board as shown on fig. 15.

Temperature sensor - installation overview:

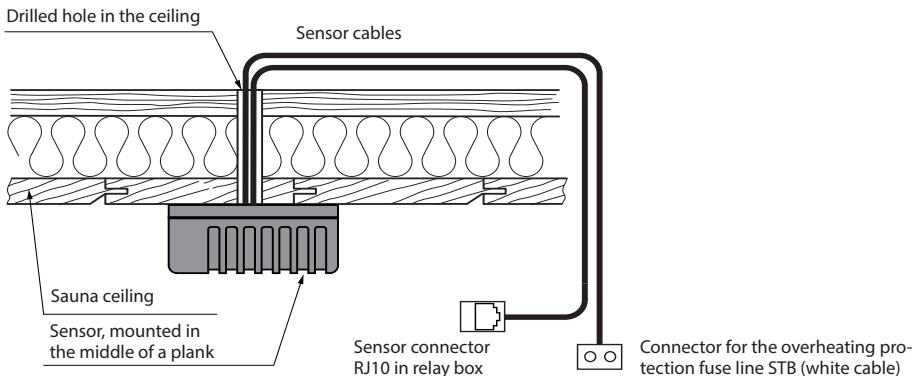

Fig. 16

Electrical connection

The electrical connections may only be carried out by a certified electrician in compliance with the guidelines of the local power supply company and applicable legal regulations (e.g. VDE norms for Germany).

In general, there may be only one permanent connection line to the network. Furthermore, equipment should be provided that makes it possible to disconnect the system on all phases from the power supply with a contact gap of minimum 3 mm.

All electrical installations and all connection lines that are installed inside the sauna cabin must be suitable for an ambient temperature of at least 170 °C.

The power supply line shall be laid to the control unit and connected to the power input terminals.

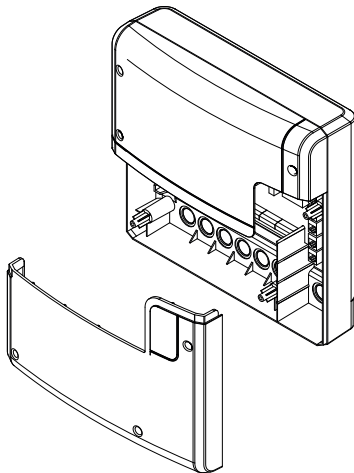

Fig. 17

Relay box, lower front cover opened

The power supply cable shall be laid to the main relay box and connected to the power input terminal as per connection diagram (see wiring diagrams, page 18-19).



Sauna heater connection

Install the sauna heater and the vaporizer in front of the air intake according to the manufacturer's installation instructions.

Draw the silicone cable through the ductwork to the relay box and connect it to the appropriate terminals as directed in the wiring diagram.

Make sure to observe the wiring diagrams on pages 18 - 19 with the corresponding terminal connection scheme.

Notice: In case there is no ductwork available drill a hole next to the air intake opening and run the heater line through this hole to the outside and to the appropriate terminals in the control unit. The silicone line must be covered to protect it from outside influences. Therefore, use a suitable cable-duct or a PVC-pipe through which you can run the line up to the power unit.

Special advice for connection of Bi-O sauna heaters to control unit models H/Hi.

Attention!

When the vaporizer is connected, the output "U" is switched from the heater to the terminal "Wb" to the vaporizer.

The sauna heater will then operate with 2/3 of the total power (if no LSG 18 H or LSG 36 H is used).



Sauna lamp connection



The sauna lamp must have the protection class of at least IPx4 and should be resistant to the ambient sauna temperatures. The sauna lamp may be installed at any location but never close to the rising hot air of the heater.

Only dimmable lamps may be used. The control unit will detect strongly inductive loads and will adjust the phase edge control accordingly.

Make sure to observe the specifications of the light output of the control unit for each light type.



Notice: for connection of not dimmable lamps there is a risk of damaging either the illuminant or the control unit. No warranty claims may be accepted in this case.



Connection of the power extension unit

The switching capacity may be extended with an external power extension unit (LSG), in order to connect and operate the sauna heaters above 9 kW power.

For connection details please refer to the installation and operation manual for the respective LSG model.



Fan

Only use fans whose speed can be controlled via phase control. The fan must have the splashwater protection class (IPx4) and must be resistant to the ambient temperature. The fan can be mounted anywhere, however never close to the rising flow of hot air from the stove and must be positioned as far away as possible from the IR spot (it may not be in the light path of the spot).



Heating time limitation

The maximal heating time may be limited with the jumper #5 on the main board of the relay box. The limitation may be set to 6 hours, 12 hours or to unlimited.

If the control unit has been set to private use, then the heating time will be automatically limited to 6 hours.

The jumper setting will override the software settings.

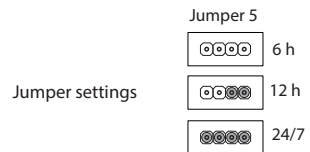

Potential-free contact

The terminals "3" and "4" on the main board of the relay box are the terminals of the normally open (NO) contact of a relay. Both terminals have no further connection and are therefore potential-free (voltage free). You can integrate this NO contact into any circuit, in order to switch an external power load or to relay a switching signal. The max. load on the potential free contact, depending on whether AC or DC shall be switched, is given in the specifications on the page 5.



Attention! If you use the terminals L1, L2 or L3 to power the circuit connected to the potential free contact, then the connection line should not be overloaded. If necessary, the load (consumer) connected to the potential free contact should be additionally protected and provided with a separate power supply.

Installation diagram Emotec D / Emostyle D/Di

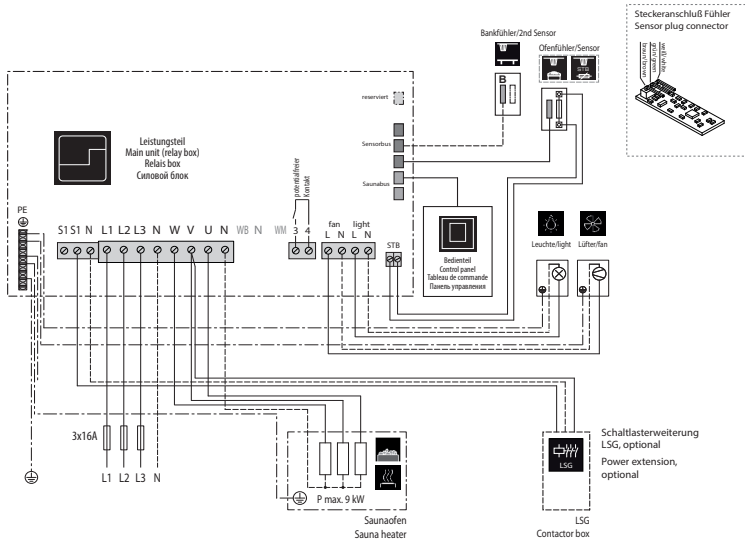

Terminal layout on the main board (relay box)

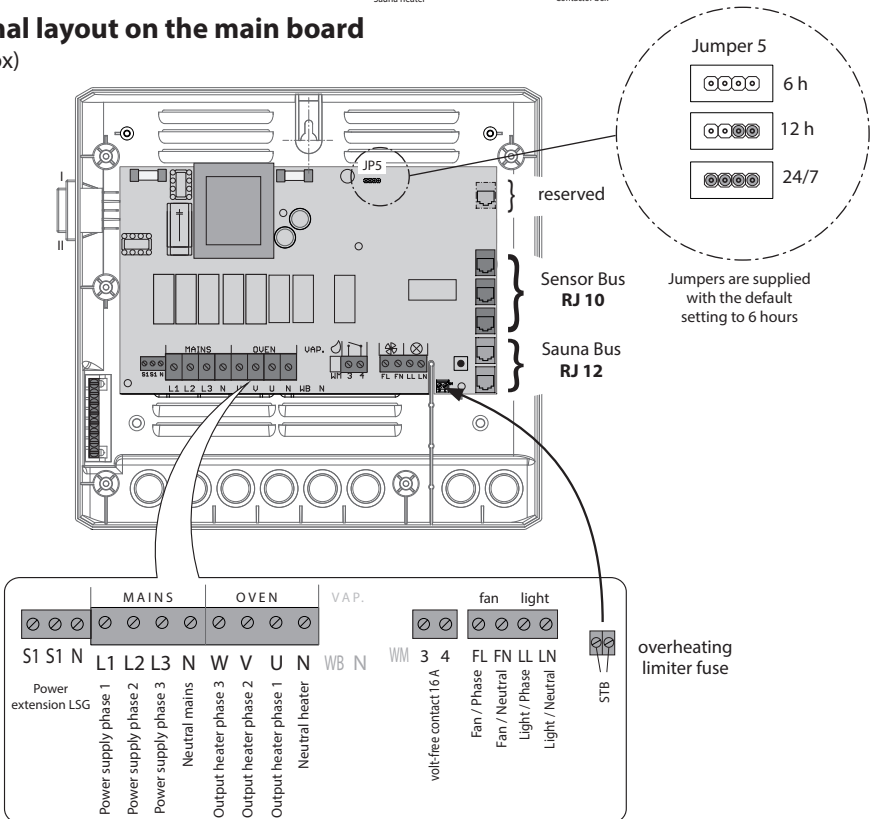

Installation diagram Emotec H / Emostyle H/Hi

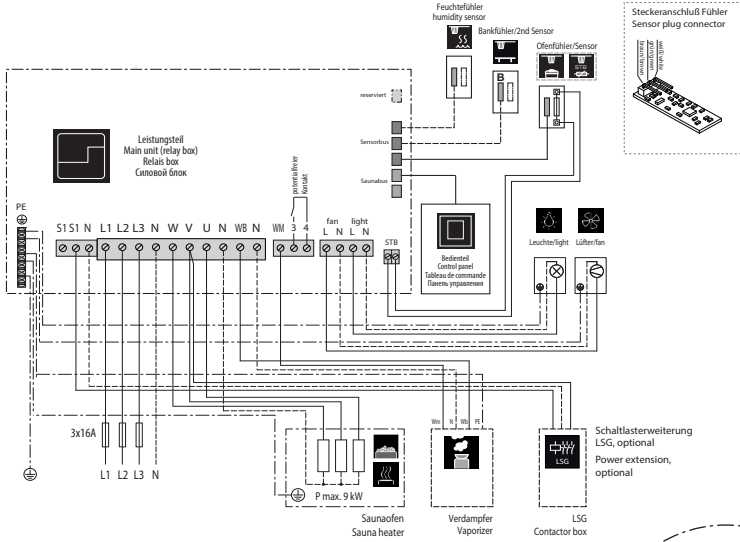

Terminal layout on the main board (relay box)

(relay box)

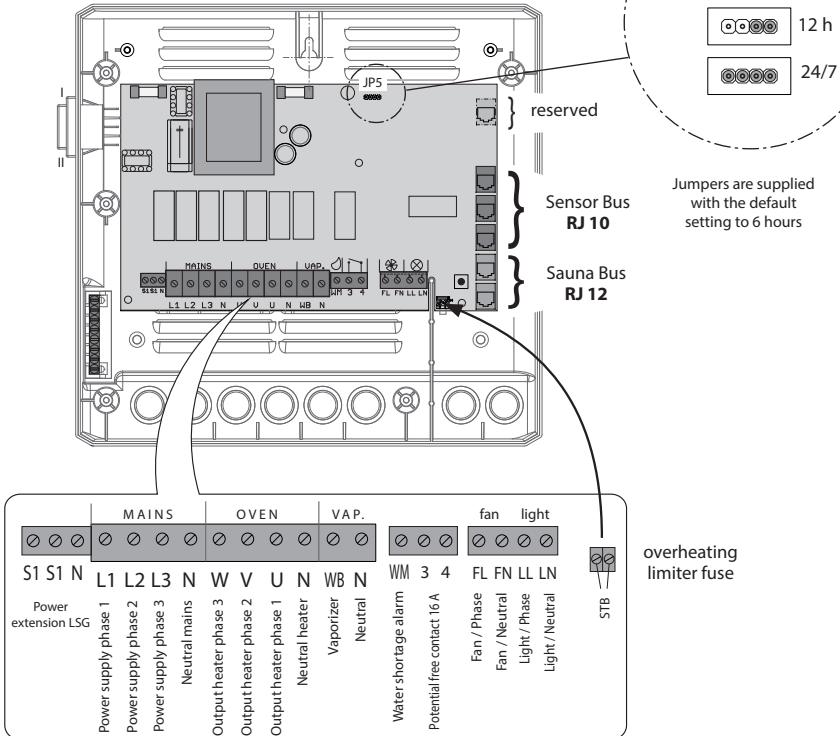

Temperature sensor

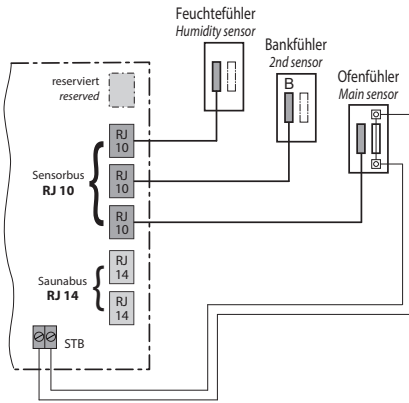

ATTENTION!

Connecting a sensor to the sauna bus connector (RJ12) may damage the sensor and the main board of the control unit!

The sensors are connected via RJ10 modular plugs to one of the corresponding sensor bus RJ10 jacks on the main board of the relay box, as shown on the left. The connection order may be chosen freely. The sensor bus supports hot-plugging, sensors may be re-connected while the control unit is switched on and will be detected and configured within 2-3 seconds.

The white cable from the overheat protection fuse in the sensor should be connected to the 2-pin STB connector on the main board.

Do not try to plug the sensors into the sauna bus connectors (two lower RJ12 jacks), this will damage the sensor and the main board.

Humidity sensor (optional, for H series)

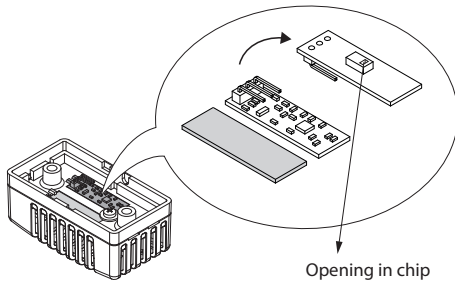

For further details please refer to page 22.

2nd sensor (optional)

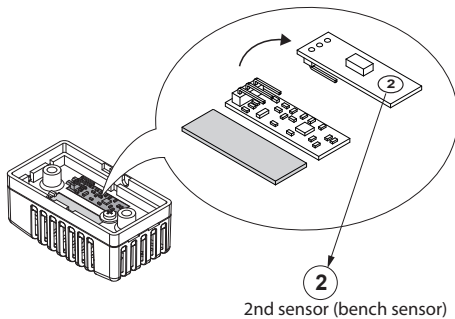

Pin-type connectors in sensor

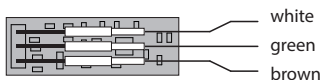

Overview - connections at Emotec D / EmoStyle D/Di

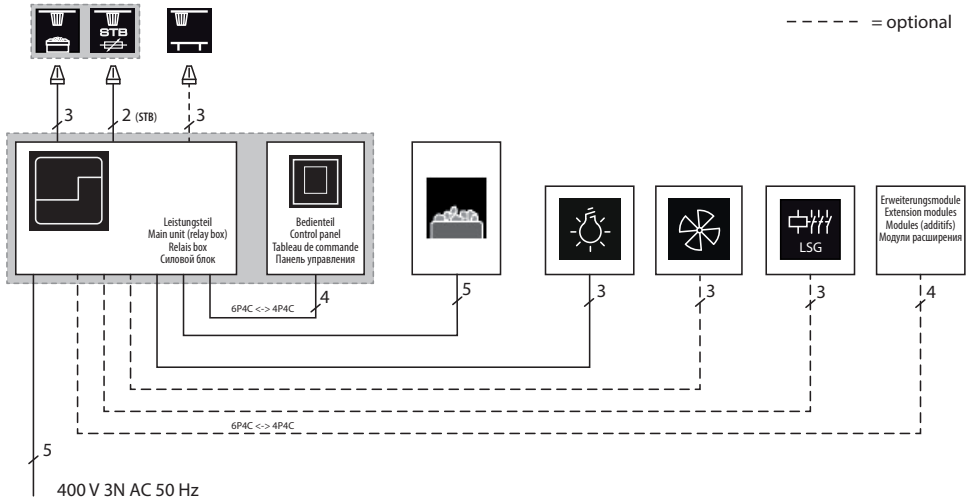

Overview - connections at Emotec H / EmoStyle H/Hi

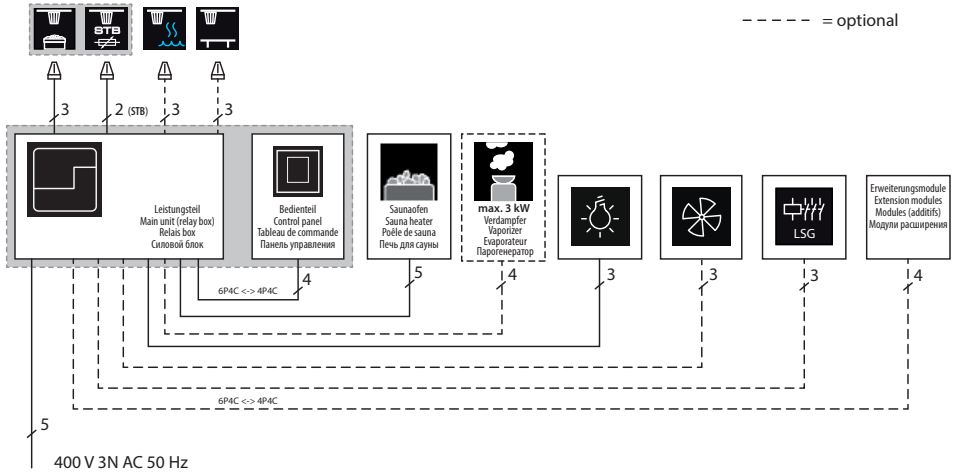

* A control lamp indicating active heating must be installed in the room or location of supervising staff in commercial saunas with disabled heating time limitation.



Humidity sensor installation

1. The humidity sensor shall be mounted in the middle of the wall opposite to the heater at approx. 150 cm height.

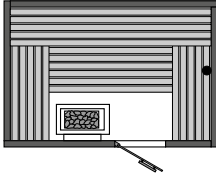

2. Connect the sensor using the included cable (5 m standard, longer line optionally available). Draw the cable with the RJ10 plug towards the control unit.
3. Connect the sensor cable to the sensor board, as shown in the diagram:

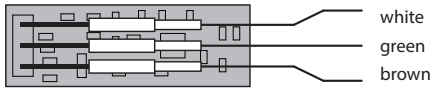

4. Make sure to connect the cable pins to the sensor correctly. Incorrect connection may damage the sensor!
5. Then connect the sensor cable via RJ10 plug to the free sensor bus jack in the relay box.
6. The successful connection of the humidity sensor the humidity symbol will change from



(humid operation mode) to indicate humidity control as per relative air humidity. The humidity sensor will be normally detected within 2-3 sec. These symbols will appear on active humidity mode either directly on the start screen (Emotec, Emo-Style models) or in a submenu for settings (EmoTouch series).

Notice: During installation of the cable DO NOT pull it by the plug - this may damage the plug connection!

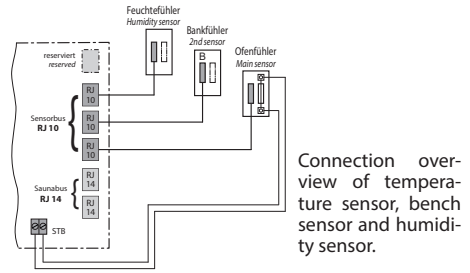

Connection overview of temperature sensor, bench sensor and humidity sensor.

Humidity control with connected humidity sensor

1. The humidity control with connected humidity sensor effects basing on the temperature-humidity curve which serves as a limit to possible values. You may set any value to the left and below the curve as shown below.
2. Values above the curve may not be set for safety reasons. If you change one parameter, the other will be automatically adjusted to keep the climate within safe limits.
3. Without humidity sensor, the humidity control is time-proportional. The humidity setting e. g. "40" means that the vaporizer will be on for 40 % of the total operating time. This method does not consider the real humidity in the sauna, but allows to produce constant amount of steam per given time.
4. With the connected humidity sensor, the humidity will be controlled as per relative air humidity in %. The control unit will try to reach and keep the pre-set humidity value.

Temperature/humidity curve as per norm EN 60335-2-53:2003

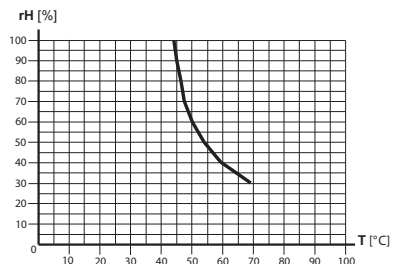



Vaporizer connection

Only for "H" series sauna control units.



ATTENTION: pay particular attention to the correct connection of the WB and WM terminals. In case of swapped connection, the detection of water shortage in the vaporizer will be disabled and the protective thermo-fuse will be bypassed. The vaporizer may overheat!

Risk of fire!

Connect the vaporizer as shown on the connection diagram given below.

Make sure to use the appropriate heat-resistant silicone cable with min. 1,5 mm² cross section for vaporizer connection.

The control unit will detect water shortage if there is zero potential at the Wm terminal of the control unit.

Pay attention to the maximum switching power of the control unit vaporizer output. If the total power of the vaporizer(s) exceeds the switching power of the control unit, you will need an external power switching relay box or contactor box, e.g. LSG18H.



Attention: Always connect the neutral (N) terminal at the sauna heater. In humid mode one phase will be switched off, the power load distribution will not be proportional. As a result the N line will not be currentless.

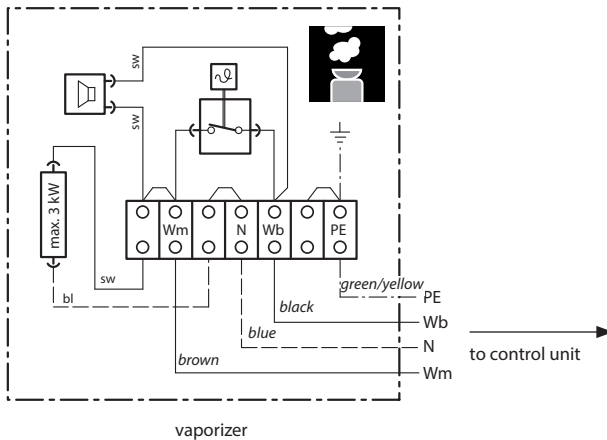



Installation of the optional bench sensor

Place of installation: The 2nd sensor (bench sensor) shall be mounted to the ceiling, over the rear bench opposite to the sauna heater (as shown on fig. 22).

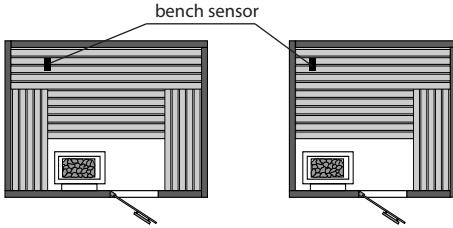

Fig. 22

The bench sensor is connected with a 3-core wire silicone cable with RJ10 plug to one of the free sensor bus jacks in the relay box, as shown on the fig. 23. Cable connection to the board inside sensor are shown on fig. 24.

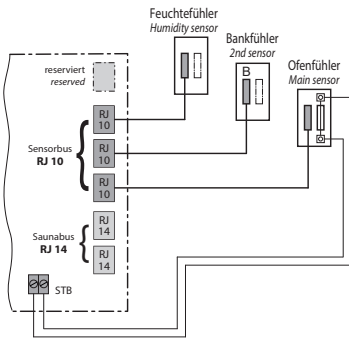

Fig. 23

With correct connection, the sensor will be automatically detected and configured. The display will show the following symbol during start-up.



Display symbol:

The sensor symbol will be displayed either on the start screen (Emotec, EmoStyle models) or in the temperature query submenu (EmoTouch models).

If the bench sensor is faulty, the temperature will be controlled via the main sensor over the heater.

After the fault is rectified, the 2nd sensor will be automatically detected and configured upon the new start of the control unit.

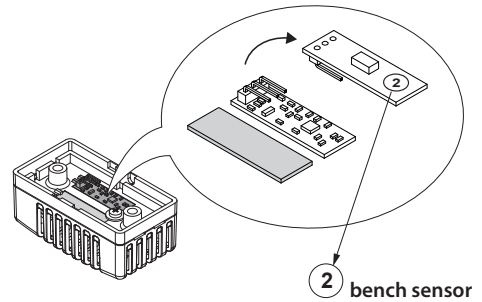

2 bench sensor

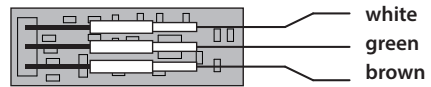

Fig. 24

The bench sensor is delivered, including a 5 m 3-core wire silicone cable with RJ10 plug. This cable shall be connected to the sensor board as shown on the fig. 24. For installation purposes the connection may be easily disconnected (pin-type connectors).

If the bench sensor is connected, it will be used to control the temperature in the sauna. The main sensor will function only as the overheating protection (139 °C limitation).

This allows to improve the air circulation in certain situations, for instance in very large saunas or by complex cabin layouts, and to achieve faster heat distribution to remote parts of the sauna.



Longer connection cables are optionally available.

Setup (commissioning / first switching)

Using the control unit for the first time or after a reset



The EmoStyle control unit offers a fast and intuitive setup upon the first switching or after a full system reset.

Select language

Select the required language with the  or  buttons and confirm your selection by pressing briefly on the enter button .



You can choose from 19 languages:

BG, CRO, CZ, DE, DK, EN, FIN, FR, HU, IT, NL, PL, RO, RU, SE, SK, SLO, SP, TR.

Only 9 languages are shown on the display at once. Press the key  or  to show the hidden languages.



Time

Set the current time. First set the hours and confirm by briefly pressing the enter button , then set the minutes and confirm your selection again by briefly pressing the enter button .

Date

Set the date, month and year.

Set the sauna use type

This step configures the essential setup for the sauna use. The control panel will ask several questions and will set the scope of appropriate features according to the selected options.

1. **Is the sauna for private or commercial use?**

Select the applicable option and press to confirm:



for private use, or



for commercial use

2. **Is the sauna installed in the EU?**

Select the applicable option and press to confirm:



- yes, in the EU, or



- no, outside EU.

3. **Safety system as per norm EU 60335 for remote switching / preset timer available?**

Select the applicable option and press to confirm:



- yes, available, or



- no, not available.

4. **Select the heater type (only by EmoStyle H/Hi).**

Select the applicable option and press to confirm:



- dry sauna heater without vaporizer (or with disabled vaporizer)



- sauna heater with vaporizer (only for EmoStyle H/Hi).

The setup is now complete and the control unit will switch to standby mode.

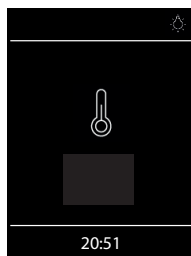

Display in standby mode for dry (Finnish) sauna operation (EmoStyle D/Di und H/Hi).
Cabin light switched on.

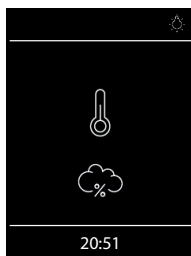

Display in standby mode for humid (Bi-O) sauna operation (nur EmoStyle H/Hi).
Cabin light switched on.

Operation

Control panel - overview

Sauna heater
(dry finnish mode if the cloud symbol is not shown)

Humid operation
% sign - humidity control as per rel. humidity in %.

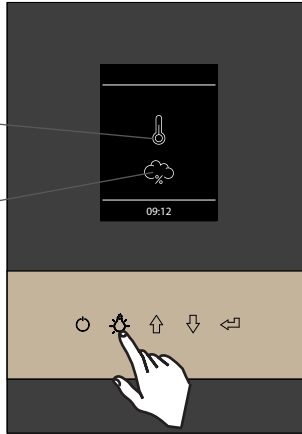

- Sauna (heating) on / off**
Press for 3 sec to switch the heater on
- Light**
on / off
- Up / Down**
Selection in the Menu
-
- ENTER**
Confirm selection of functions and settings

Fig. 1

Switching your sauna on / off

In order to switch the sauna heater on, press the button for 3 sec. The sauna will switch on after the countdown with the preset parameters (e.g. temperature, etc.). To switch off, press the button again shortly.

Switching the light on / off

Press the button on the front panel to switch the light on or off.

Settings

Press the button or to reach the settings menu. A window, as shown on fig. 2, will open.

With EmoStyle Hi models (with enabled vaporizer) the symbol for a quick selection between the dry and humid sauna mode will be shown at the first place.

Settings interface for EmoStyle Hi. The symbol for dry or humid mode selection is shown as the 1st option.

Settings interface for Di or EmoStyle Hi (with disabled vaporizer).

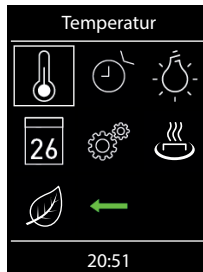
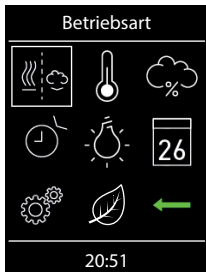







Fig. 2

Notice: If the display of the control panel remains dark after switching the power supply on, please check the position of the unit's main switch (Switch-Off rocker switch), located on the main electronics unit (relay box). See chapter "Switch-Off rocker switch" for more details.

Operation principle

Press the button  or , in order to select a function (icon). Press shortly the ENTER button  to open this function. Press the buttons ,  to change the value (changed value turns from white to green). Press the ENTER button  to save (confirm) the setting and exit, the control panel will then return to the previous (upper) menu.

Symbol description - main navigation menu



Operation type (only Emostyle Hi)

Selection between dry and humid mode (the vaporizer must be connected and enabled).



Finnish sauna mode

Selection for operation in dry Finnish mode (submenu of the operation type).



Humid sauna mode (Bi-O)

Selection for operation in humid mode. (submenu of the operation type).



Temperature

Setting of the target temperature in the sauna cabin.



Humidity

Setting of the target humidity value in humid operation mode. %-sign indicates a connected humidity sensor (rel. air humidity control).



Auto-Start

Pre-set timer for later automatic switching on of the sauna up to 24 h in advance.



Light

Setting of the desired light intensity and light switching (light dimming 0 - 100%).



Timer

Setting for automatic switching on via calendar. A single event switching or regular week timer switching is possible.



Extended settings

Submenu for further settings. Like e.g. language, time, date, screensaver, child lock, heating time, etc.



Potential-free contact

Switch for the potential-free contact (output).



HOT-Start (only with Finnish sauna mode)

HOT-function can only be started, not stopped. Icon only appears when the heater is on



ECO-Start / ECO-Stop

ECO-function can be started and stopped. Icon only appears when the heater is on



Back

Return to the upper menu.

Hint:

The on/off switch  on the control panel front functions as a "home" button during settings and allows you to quickly return to the start screen. Simply press shortly on this button. Please remember that all not yet confirmed settings will be lost in this case.

If you do not operate the ENTER button  for more than 20 seconds, the control unit will return to the start screen. All not confirmed settings will be lost in this case.

Thanks to the integrated battery (CD2032 type, in control panel), all settings will be stored in the memory and will be retained even in the case of a very long time power loss.

New extension modules and optional equipment will be normally automatically detected and configured. Upon restart the control panel will show the corresponding new symbols in the menu navigation.

Graphic user interface (GUI) and the current climate conditions check

Thanks to the modern graphic user interface, you can quickly access all functions and make necessary settings, as well as make a simple instant query for the current sauna climate condition.

The symbols on the start screen may be displayed in different colours, in order to indicate the current operation status - e.g. white colour for standby and red/blue colour for active heating.

For every selected symbol the control panel will display the meaning of this symbol at the top in one of 19 languages and will provide additional text hints by various settings. For language selection please see the next chapter.

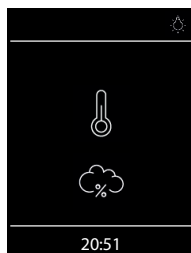

Start screen (standby mode)

In standby mode the display will show the symbol for the heater (thermometer). For EmoStyle Hi in humid mode a cloud symbol will be additionally displayed underneath (symbolizes the vaporizer).

The “%” sign in the cloud means that the humidity sensor has been detected on the control unit (means humidity control as per rel. air humidity).

The light symbol will appear at the top right corner if the light has been switched on. The clock will be displayed at the bottom.

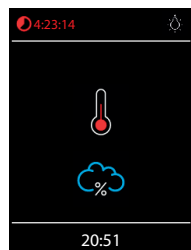

When the sauna is switched on - the thermometer symbol starts to pulse red during the heating time, afterwards it will continuously light in red.

The countdown of the remaining heating time will be shown in red at the top left corner. You can stop the heating at any time by shortly pressing on the on/off button .

The blue cloud symbolizes the active humid mode. Humidity regulation starts after the target temperature has been reached. After the humid mode, a “sauna-dry” program will start (up to 30 min., only the heater will run), unless this program has been disabled in the setup.

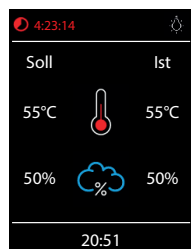

Checking the target and current sauna climate condition

You can quickly check the pre-set (target) and the real temperature (and humidity for Emostyle Hi). Press the ENTER button  for approx. 3 seconds.

The target and current values will be displayed on the screen. The current values correspond to the values measured at the respective sensor.

If the 2nd sensor (bench sensor) is installed, then the current temperature will be shown as measured by this sensor.

Without humidity sensor only the pre-set proportional vaporizer switching will be shown, with humidity sensor the target and the real humidity in % will be shown.

Notice: Please pay attention that the shown values for the current temperature (humidity) are measured at the sensor location point. Because of the considerable differences in temperature in different parts of a sauna, these values may vary from the values shown by the instruments mounted at the sauna wall. We recommend to maintain the climate as it is pleasant to you instead of blind orientation on some suggested values.

Operation and program settings



Sauna on / off

Press the button on the control panel for approx. 3 seconds to switch the sauna on. Count-down runs . The display will show the active heating state (see previous page). The cabin light will be also switched on.

To switch the sauna off press the button shortly. For Emostyle Hi models in humid mode the “sauna dry” program will switch on for 30 min. after the main operation. After this program the sauna will switch off completely.

You can stop the “sauna dry” program at any time - just press the button again shortly.



Light on / off

Press the light button on the control panel to switch the cabin light on or off.



Sauna operation mode - dry sauna or humid (Bi-O) sauna (only EmoStyle Hi)

Press the UP/DOWN button in the main menu and choose the operating mode with the symbol.

Select for the dry Finnish sauna or for the humid (Bi-O) sauna mode.



Temperature

Select and press the temperature symbol in the main menu. A submenu will open and show the current value. Set the new temperature with the ENTER button. Press the ENTER button to confirm and exit. This setting can be also made during active heating.

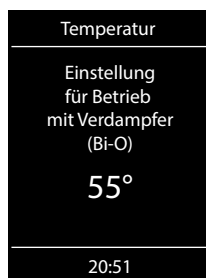

Humidity (only EmoStyle Hi)

Select and press the humidity symbol in the main menu. A submenu will open and show the last stored humidity value. Set the desired humidity with the UP/DOWN button. Press the ENTER button shortly to confirm the setting and exit. This setting can be also made during active heating (in humid mode).

With a connected humidity sensor (% sign appears inside cloud) the relative air humidity will be controlled. Without humidity sensor the humidity will be controlled in proportional to time way. “30%” then means 30% of the total heating time. The display will show the symbol.

Please observe that with a humidity sensor, the humidity setting will depend on the pre-set temperature. For safety reasons only the values to the left and under the curve may be selected. For instance at 60 °C temperature you can set up to 40 % rel. air humidity. In order to set a higher humidity, you will first need to reduce the temperature.

If the sauna has been used in dry mode with high temperatures and you switch to the humid mode, the vaporizer will only start to work after the temperature drops under the max. allowed level (70 °C).

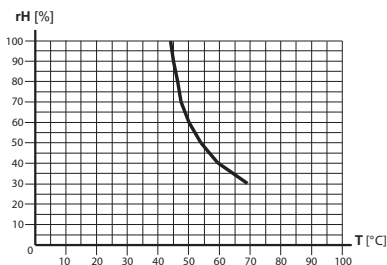

Time pre-selection (Auto-Start)

With this function you can program your sauna to switch on at a later time with up to 24 h delay. In the main menu select and press the timer symbol



with the ENTER button. A submenu will open and display “--:--”. Press the UP/DOWN button to set the hour for the desired automatic switch on time.

Press the ENTER button to confirm and to jump to minutes. Now set the desired value for minutes and press the  button to save the setting and exit. At the start-screen you will see the blinking timer with the programmed time. This time means the time of day, not the delay in hours/minutes from the moment of setting.

To delete the pre-set auto-start timer, simply press shortly on the on/off button. The blinking timer indication shall disappear.



Attention! This function is only allowed to be used if your sauna is equipped with an approved safety system, which prevents the heater from being switched on in an unsafe condition (e.g. a towel forgotten on the heater). Even in the case if your sauna has such an approved system, assure yourself that there are no objects forgotten on the heater. Risk of fire!



How to dim the cabin light

The light button on the control panel  allows to quickly switch the light on/off. In the main menu you can adjust the light brightness (dim the light 0-100%) via the same symbol. 0-10% in single steps, 10-100% in 5 steps.

Press on the  light symbol with the ENTER button. The cabin light will switch on (if not yet switched on) and a submenu will open and display the current light setting in %. Press the UP/DOWN button to adjust the brightness to the desired value. Press the ENTER button to confirm the new setting and to exit the submenu.

Please observe that the light dimming will only function if a dimmable transformer or a regular resistive load incandescent bulb has been connected. Make sure to observe the minimum and maximum power load for the connected lamps (see specifications or contact your dealer).

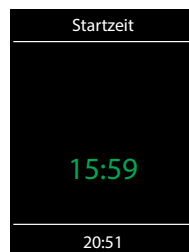



Timer (switch-on time pre-selection)

The timer function allows you to have your sauna switched on automatically with the desired climate condition. You have two possible options:





- single event (single time switching, not recurrent)

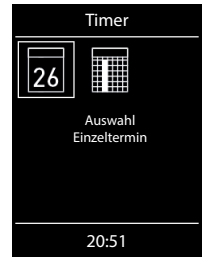

- week timer (regular, recurrent switching for the given day of the week, e.g. Monday, with up to 4 switching programs per day).



Attention! This function is only allowed to be used, if your sauna is equipped with an approved safety system, which prevents the heater from being switched on in an unsafe condition (e.g. a towel forgotten on the heater). Even in the case if your sauna has such an approved system, assure yourself that there are no objects forgotten on the heater. Especially with an active week timer - make sure to check your sauna regularly for safe conditions. **Risk of fire!**

For single event switching press on the  symbol in the main menu. In the submenu (see example above) press again on the  symbol for the single event programming.

Now set the day, month and year for the desired switching. Then in the new window set the start time (hours and minutes). Then in the new window set the operation type (dry Finnish sauna or humid sauna). Then as the last step set the preferred temperature and humidity (only for humid mode). The programming window will close after the last step. At the start screen in the bottom right corner you will now see the flashing programmed time (date and time, e.g. 15.01. and 18:30). If you want to cancel this program, just press shortly on the on/off switch. The flashing date and time indication will disappear. This program will also be automatically cancelled if you switch the sauna manually.

For week timer programming press on the  symbol (week timer). A new window with seven numbered squares will open (from 1 to 7).

Notice: white colour means an empty program place. Green colour means there is a program for the given day.

Select a day of the week, for which you would like to assign a program (e.g. "1" for Monday) and press on the ENTER button.

Notice: You can assign up to 4 programs to each day of the week. The max. heating time for each switching is 12 h. A 6 h pause must be observed after 12 h non-stop heating as per legal regulations. The next program may therefore start only after a 6 h break if the previous program duration has been set to 12 h. If you wish a shorter pause, then set the heating time to less than 12 hours.

Furthermore you can assign individual temperature (and humidity for Emostyle Hi) to each program for automated sauna operation. This allows to implement flexible energy management schemes in your sauna - for instance during peak-off times you may set the sauna to run at lower temperatures with reduced energy consumption, so that it can then reach the full temperature faster at the main time of use.

Now select the program (1 of 4) and press the ENTER button.

1. Set the required start time (hours and minutes) - e.g. 9:30.
2. Set the required heating time (hours and minutes) - e.g. 3:30.
3. Set the required operation type - dry Finnish sauna or humid sauna (only Emostyle Hi)
4. Set the required temperature.
5. Set the required humidity (only EmoStyle Hi).

After the last step the control panel will return to the week overview. All days with assigned programs will be displayed in green. Repeat the above steps for every new program you may require (max. 4 per day). After you return to the main start screen, you will see the indication of the next (earliest) switching time flashing in the bottom right corner (e.g. Monday, 9:30).

How to delete or change the week timer

In order to delete or change the program, open the week timer via the main navigation menu.

1. Select the respective day of the week.
2. Select the respective program number.
3. Make the necessary adjustments (start time, heating time, temperature) or...
4. to delete the program, set the start time (hour and minutes) to "--" and shortly press the ENTER button twice to confirm and exit.
5. The display will return to the week overview.



Notice: With an active week timer you will always see the next earliest switching time displayed flashing in the bottom right corner. Also if you programmed several switching times or a combination of the single event switching and week timer switching.



Potential-free contact

With the potential-free contact (output), you can switch an external device up to 16 A on or off. This function has to be enabled in the setup menu and the external device has to be properly connected and configured.

Please observe that the potential-free contact output only provides a switching signal.

In the main navigation menu select the  symbol and press the ENTER button. In the submenu you can now select and press on the  (on) or  (off) symbol in order to make the respective switching.

If you cannot find the symbol of the potential-free contact in the main navigation menu, please contact your local dealer to have this function enabled.



HOT-function

With the HOT-function you can give an additional performance boost in the sauna where the sauna heater will heat without interruption for a preset time (5 - 20 minutes). The set-point temperature is increased to 115 °C, the cabin fan runs at full speed. The maximum temperature 115 °C is not exceeded for safety reasons.

The HOT-function is only possible during Finnish operation.

The HOT-function can be activated manually via the optional HOT-button or automatically at pre-programmed intervals.

Once the sauna is switched on to Finnish operation, the symbol of the HOT-function appears in the main menu. Select this symbol and press the ENTER button. In the submenu you can activate the HOT-function. If an ECO-function is running, it will be stopped when the HOT-function starts.

NOTICE: once the HOT-function has started, it cannot be interrupted anymore.

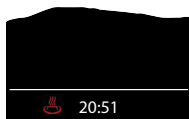

While the HOT-function is running, the corresponding icon in the status bar will appear on the screen.



HOT - additional functions

With the code 7020 the process of each HOT-heating phase can output a 3 sec. long pulse via the potential-free output (PFC), e.g. to start the automatic water splash system "Aquadisp" or to control a sensor, e.g. Gong.



ECO-function

The ECO-mode allows you to reduce energy consumption by manually lowering the sauna temperature when the sauna is not used for a certain period of time (idle). The ECO-function is only possible during operation.

Once the sauna is switched on, the corresponding ECO-symbol appears in the main menu. Select this symbol and press the ENTER button. In the submenu you can activate the ECO-function. The ECO-function cannot be started when the sauna is already running in HOT-mode. The ECO-mode can be aborted at any time or programmed for a specific automatic duration up to 240 minutes.



ECO lowers the set-point temperature ($T[\text{set}] - 30\text{ °C}$) / 2, the cabin fan turns off.



While the ECO-function is running, the corresponding icon in the status bar will appear on the screen.

Symbol description - extended settings

The submenu "extended settings" provides a range of additional functions, which normally need to be set only once or quite seldom.

Select the symbol  in the main menu and shortly press the ENTER button .



Language

Allows to set the language for the menu navigation. 19 languages are available:

DE, EN, FR, RU, ES, NL, IT, PL, SLO, FIN, TR, CZ, RO, BG, HU, HR, SK, DK, CRO, SE



Time

Here you can set the time of day.



Date

Here you can set the date, month and year.



Screensaver

Here you can set the interval, after which the display will show the screensaver with floating clock.



Sleep mode

Here you can set the interval, after which the control panel goes into sleep mode in order to save power. Press on the buttons to wake up the unit.



Child lock

Here you can lock the unit with own Pin-code. It will be still possible to switch off the heater and to switch the cabin light.

Please observe the special advice below.



Heating time (Auto-Stop)

Here you can set the desired heating time. For private use - up to 6 hours, for commercial use - up to 12 hours or 99 hours.



Operation data

Here you can check the firmware version, the remaining time until the next service, as well as the contacts for service issues.



Display brightness

Here you can change the display brightness in three steps.



Holiday home mode



Here you can restrict the user's access to the minimum functions with an own Pin-code.



Important advice for Child Lock function

You can completely lock the control panel via  symbol with an individual pin-code. During active lock you can only switch off the heater (if it is heating) and switch the cabin light. If you attempt to reach any function you will be prompted to enter the pin-code.

How to reset the pin-code:

If you forgot the pin-code proceed as described to reset it. Press the on/off button or any other button to initiate the pin-code prompt, do not change the four "0" digits, confirm the first „0" with the button , then press and hold the button  pressed at the second "0" (first two zeros turn green, the cursor will move to the third zero).

After approx 40 seconds all zeros will turn white. Now confirm all zeros (do not change them!), the display will return to the start screen and the Child Lock will be reset.



Extended settings



Language

Here you can set the language for the menu navigation and messaging system. Press on the language symbol, in the submenu select the required language and shortly press on the ENTER button to confirm. All texts will then be shown in the new language.



Time (clock)

Set the hours and minutes by pressing the , button and confirm each setting by shortly pressing the ENTER button .



Date

Here you can set the date (day, month, year). Press the , button to set the day, month, year and confirm each selection by pressing . After the last setting, the unit returns to the previous menu.



Screensaver

This setting defines the period of time after which the control panel will enter the screensaver mode if no button has been operated. In this mode the display brightness will be reduced to the minimum and the display will show the current time (or EOS-Logo et al enlarged) floating across the screen. Press the , button or press on the on/off button shortly in order to return to the start screen.



Sleep mode

This setting defines the period of time after which the control panel will enter the sleep mode. In sleep mode the display will be switched off completely. Press , button or press on the on/off or light button to wake the control panel. This function is only active if the heater is not switched on.



Child lock / Operation lock

You can lock the control panel with the individual 4-digit pin-code, in order to prevent the unauthorized access.



In order to lock the control panel, select the “lock” symbol and press the button shortly. A submenu will open and display “0000”. You can now replace the zeros with your personal 4-digit pin code. Press , button to select a number, press on the button to confirm it and to

jump to the next digit.



After the 4th digit confirmation the display will return to the start screen and the unit is now locked. No settings are possible.

For safety reasons it is still possible to switch off the heater (interrupt active heating) and to switch the light while the unit is locked. All other functions will be locked.

For all other operating attempts, the request for PIN code entry appears.

To unlock the unit press ,  in order to call the pin code prompt. Now give in your pin code. The unit is now unlocked.

How to reset the pin code

Press any button (except “light”) to launch the pin code prompt, do not change the “zero” values, confirm the first zero (press ) , then hold the button  pressed for the second zero (first two zeros turn green, the cursor jumps to the third zero).

After approx. 40 seconds all four zeros will turn white. Now confirm all four zeros with the ENTER button - upon exiting the unit will be unlocked.



Heating time

Here you can set the required heating time duration for your sauna heater.

For private use the max. heating time is limited to 6 hours. For commercial use the max. heating time may be limited to 6 hours, 12 hours or set to unlimited. This limitation should be set in hardware during the installation and setup (jumper 5 setting)

Press with the ENTER button on the  symbol and set the required heating time in hours and minutes. This setting will then be valid for every manual sauna switching.

After switching the sauna on, the remaining heating time will be displayed as a countdown clock in the upper left corner. So you can check at a glance the remaining heating time of your sauna.

Please observe that after the humid mode operation (only EmoStyle Hi) the sauna heater will be switched in the “sauna dry” mode, in order to dry your sauna cabin. The default sauna dry mode duration is 30 minutes. This time may be reduced (also the pre-set temperature and fan operation time may be adjusted) in the setup menu. Please contact your dealer for further details.

The heating time may be changed with 1 minute steps. The minimal heating time is 1 minute.

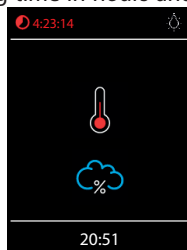



Operation data

Here you can check the important information concerning your control unit (sauna) operation.



Firmware - allows to check the currently installed firmware version. Press the UP/DOWN button to switch between two possible parameters. "Panel Vx.xx" - shows the firmware in control panel, "Mod-LS Vx.xx" - shows the firmware in the main relay unit (x stands for a number). Press on the ENTER button to close this submenu.



Service intervals - allows to check the remaining time until the next pending servicing / maintenance of your sauna. The intervals will be set by your dealer (installer) during the installation and setup.



Contacts - shows you the contact information of the sauna control unit manufacturer or your dealer (installer). This information will be also displayed by faults along with the error messages.



Display brightness

Here you can set the display brightness in 3 stages.



Holiday home mode

With this function you can restrict the access to the control panel with your own pin code down to the bare minimum of functions. All other functions will be disabled and their symbols will not be displayed.

Following settings are possible when the holiday home mode is active:

- Sauna on / off
- Light on / off
- Selection of the operation mode - dry or humid (only for Emostyle Hi)
- Temperature setting
- Humidity setting (only for Emostyle Hi)

To activate the mode press on the  symbol. A pin code prompt window with default "0000" will open. Instead of the four zeros, you can now enter your own PIN code. Press the UP/DOWN button to select a number and press shortly the ENTER button to confirm it and to jump to the next digit. After the 4th digit the display will return to the start screen and the holiday home mode will be activated.

Hint: To cancel the activation while setting the code, shortly press the on/off button.

To unlock the control panel press the UP/DOWN button to reach the main navigation menu in which you find the  symbol at the last place. Press on this symbol. The pin code prompt window will open ("0000" default display). Enter your pin code to unlock the control panel.

Reset holiday home mode

Select the  symbol and press the ENTER button  for approx. 1 minute. The pin code prompt will open and after confirming all four zeros, the control panel will be unlocked.

The holiday home code will be deleted and the device will be unlocked.

Manual setting of the lamp

The control unit is factory set to inductive lighting load. Hence, resistive loads can also be controlled. If required, the light output can also be switched manually to capacitive loads.

When using incandescent lamps, the lighting load must remain set to inductive load.

The current setting is shown on the display.

Code **8001**  Inductive / resistive load when using incandescent lamps
factory setting

Code **8002**  Capacitive load
electronic ballasts for reverse phase control



Improper settings can damage the device. In this case, the warranty expires.

The work may only be carried out by a trained specialist from an authorised electrical company.

Set lighting load to resistive load

- If applicable, open the housing of the power unit.
- Check whether the power unit is disconnected from the power supply.
- Disconnect the light on the mainboard.
- Switch on power unit and control panel.
- Press



5 sec.

- Enter code and confirm.



Code **8001**: Inductive / resistive load, when using incandescent lamps

Code **8002**: Capacitive load, electronic ballasts for reverse phase control

- Disconnect the power unit from the mains and reconnect the lamp.
- Close the housing.
- Restore the power supply and switch the power unit back on.

here: display of light output



Service- and Setup

The control unit provides an extensive scope of functions for setup and fine-tuning of the sauna equipment, in order to optimize sauna operation. **This setup menu is protected with a PIN code and should not be accessible to the end users.**

Hint: a short version of the operation manual without setup and installation is included in the delivery. Hand it over to the end client and retain this manual for yourself.

In the main menu select the  symbol and press the ENTER button for approx. 6 - 7 seconds until a pin code prompt window opens.

Your PIN code: **5349**

Please make sure to retain this PIN code at a safe place and do not disclose it to the end clients, in order to prevent unauthorized access to the basic setup and safety-relevant features.



Press the ENTER button for approx. 6 - 7 seconds.

>>



Enter the PIN code

Service & setup level user interface

Depending on the model (D/Di or H/Hi) the available functions will be shown as symbols. For H/Hi models some symbols will not fit the window and will be hidden. Press the UP/DOWN button to scroll and show them on the display (the window scrolls down).

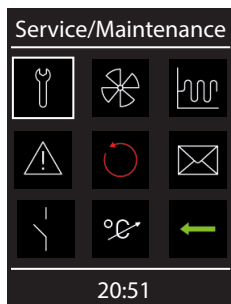

Service level interface EmoStyle D/Di

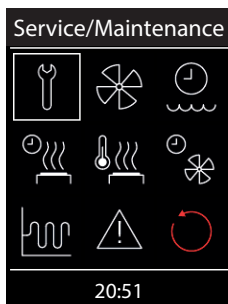

Service interface EmoStyle H/Hi
(immediately visible symbols)



interface EmoStyle H/Hi
(the lower hidden part of the window)

Symbol description



Service / maintenance intervals

Setting the intervals for service / maintenance.



Temperature adaptation

Setting for the temperature offset +/- °C.



Fan

Fan speed settings.



HOT-time

Setting in minutes (5-20 min.)
Only for dry Finnish operation.



Refilling time

Switch-off time settings (only for EmoStyle H/Hi)



HOT-auto interval time

Setting range: 30 to 480 min.
Only for dry Finnish operation.



Afterheating time

Setting for humid operation in minutes. (only for EmoStyle H/Hi)



HOT-auto start time

Setting range: 0:00h to 23:59h and --:--
Only for dry Finnish operation.



Afterheating temperature

Setting for humid operation in °C.
(only for EmoStyle H/Hi)



HOT-auto switch-off time

Setting range: 0:00h to 23:59h and --:--
Only for dry Finnish operation.



Fan running time

Fan operation time in minutes.
(only for EmoStyle H/Hi)



ECO-time

Setting in minutes (0-240 min.)



Hysteresis

Setting of the switching hysteresis



back

returns to the menu



Usage

Selection for private or commercial use and selection of the sauna heater



Reset

Reset to the factory default settings, all individual settings will be deleted.



Contact details

Displays stored contacts.



Potential-free contact

Enables or disables the potential-free contact switching function.



Service intervals

Allows to set the intervals for servicing and maintenance. Upon expiry the control panel will remind the user for a short time upon every switching about the pending servicing. The end user can check the remaining time to the next servicing in the extended settings menu. This function allows as well to keep track of the total operation time of the sauna.

Default setting for private use - 500 hours.

Default setting for commercial use - 2500 hours.



Fan

Here you can set the fan operation speed in 3 stages or disable it. If activated, the fan will automatically switch on with the heater (synchronous operation). In "sauna dry" program the fan will always operate at the highest speed.



Refilling time (only H models)

Here you can set the grace time which the end user has to refill the vaporizer after the water shortage alarm. If the vaporizer has not been refilled within this time, it will be switched off (overheating protection). This function is especially important for Bi-O heaters with manual refilling.



After-heating time (only H models)

Here you can set the time for the "sauna dry" program after the humid operation. Factory default setting is 30 minutes. After every humid operation the sauna will then switch on in dry Finnish mode, in order to dry the cabin. We recommend to use this function in combination with the exhaust fan, in order to remove the humidity and dry the sauna cabin.



After-heating temperature (only H models)

This functions allows to set the temperature for the "sauna dry" program. Factory default setting is 90 °C.



Fan running time (only H models)

Here you can set how long the fan should operate after the Finnish or humid mode operation of 0-60. Factory default setting is 30 minutes. We recommend to use this function in combination with the "sauna dry" program, in order to remove the humidity and dry the sauna cabin.



Hysteresis

Allows to adjust the hysteresis within a 1-10 K range. This adjusts the tolerance level around the temperature set-point and influences how often the heater will be switched on or off by temperature changes. For instance at 90 °C target temperature and hysteresis set to 5 K the control unit will switch the heater on at 85 °C and off at 95 °C respectively. This allows you to better adjust the sauna heater to the specific sauna cabin size and layout.

Attention! The smaller hysteresis value will lead to considerably increased number of relay switchings, which reduces the service life expectation of the control unit! The factory default setting is 5K.



Usage

Here you can set the sauna use type to private use or commercial use. The control unit will adjust relevant settings accordingly. For instance, the maximum heating time limitation.



Reset

Allows you to reset the unit back to the factory default settings. All individual settings will be lost. The control unit will restart and will prompt to perform the basic setup steps as by the first switching.



Contact details

Here you can check the stored contact details. By default the contacts of the control unit manufacturer will be shown. If an optional micro-SD card with personalized firmware is inserted, the individual contact details will be shown.



Potential-free contact

Allows to enable or disable the potential-free contact switching function. If enabled the corresponding symbol will be shown in the main navigation menu, so that the end users may switch the connected external equipment. By default this feature is disabled.

The middle symbol  allows to synchronize the volt-free contact switching with the S1 output. This means the contact between terminals 3 and 4 will be closed if the sauna is switched on.



Temperature adjustment (offset)

With this function you can adjust the displayed set point temperature of the control unit in relation to the real set point value. For instance, if the thermometer shows air temperature 5 °C below the set point value you can compensate this difference by adjusting the temperature offset to +5K. The control unit will then heat with the effective set point 5K above the displayed set point which allows to reach a higher temperature, in order to match the value shown on the thermometer.

NOTICE: Since this function bears certain risks, it may only be used by experienced and appropriately qualified persons and should be properly tested.

Possible adjustment range is from -10K to +10K.

Please make sure to observe the maximal allowed temperatures as per norm EN 60335-2 part 53.



HOT-time

In this menu the duration of the HOT-function is set. During this time, the set-point temperature is increased to 115 °C to produce a short-term performance boost.

- Setting range: 5 to 20 minutes.
- The factory default setting is 10 minutes.



HOT-auto interval time

You can start the HOTAUTO-function automatically at specific time intervals. In this menu the interval for this automatic switch-on can be set.

However, the HOTAUTO-heat-up phase starts effectively a little earlier, before the set time according to the set duration. Thereby the sauna stones reach the ideal temperature at the desired start time.

If the system started at a time when the preselected time period of the heating phase should have already started, the next step of the HOTAUTO-interval is executed first.

Example: When setting the start time: **8:00** and duration: **20 minutes**, the HOTAUTO-heat-up phase begins at 7:40, with a duration of 15 minutes - at 7:45, with a duration of 10 minutes - at 7:50.

- Setting range: 30 to 480 minutes
- Increment: 30 minutes
- Factory default setting: 60 minutes



HOT-auto start time

- In this menu, the start time for the HOTAUTO or for the first water splash can be set
- Setting range: 0:00 Uhr to 23:59 Uhr, --:-- corresponds to HOTAUTO deactivated
- Factory default setting: --:--



HOT-auto switch-off time

- In this menu, the switch-off time for the HOTAUTO can be set
- Setting range: 0:00 Uhr to 23:59 Uhr, --:-- corresponds to HOTAUTO switches off with sauna
- Factory default setting: --:--



ECO-time

The duration of the ECO-function can be set in this menu. Upon expiry, the control unit returns to the normal temperature range.

- Setting range: 0 to 240 minutes, 0 corresponds to only manual deactivation of the ECO-function
- Increment: 30 minutes
- Factory default setting: 0 (only manual deactivation of the ECO-function)
- Notice: at setting 0 - ECO-mode will expire after 18h.



Back (exit service level)

Select and press the  symbol in order to exit the service level. Alternatively you can shortly press the "Home" button (on/off button).

The service level will be automatically closed, if you do not operate the control unit for 15 seconds.

The control panel will then return to the start screen.

Troubleshooting (error messages)

The control unit detects various disruptions and errors and displays them on the display. These are displayed in plain text, so that the error identification and search is much easier. In addition, the device also alternately displays the stored contact information, so that customers can immediately contact them to have the error rectified.

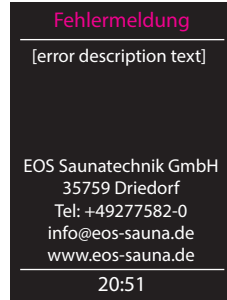

Errors / Error messages

	Reason / Troubleshooting
Display remains dark	<ul style="list-style-type: none">• No power supply - check fuses, check cables.• Switch-Off switch in off position - check the device's main switch for correct position.• Faulty connection to control panel - check the link cable (rely box - control panel) for reliable connection.• Control panel in sleep mode - rotate the jog dial (Emotec) / press UP/DOWN or ENTER button (EmoStyle).
Sensor fault	<ul style="list-style-type: none">• Faulty connection to the main sensor - check the sensor and cables for reliable connection.• Faulty sensor- get the sensor replaced by the dealer.
Thermal fuse triggered	<ul style="list-style-type: none">• Faulty connection - check the white cable (loose wire, faulty contact, etc.)• Thermal fuse blown because of overheating - check the possible reason for overheating, replaced the fuse (one spare fuse is included with every controller).
Water shortage	<ul style="list-style-type: none">• Too little water in vaporizer - refill water. Observe the pre-set grace time for refilling, otherwise the vaporizer will be shut-down!• By automatic refilling - check the water supply line, check the FWA water level control device.
No Bus communication	<ul style="list-style-type: none">• Check the cable connection between the relay box and the control panel.• Restart the control unit; if the fault persists, contact the dealer or EOS service.
Unknown error	<ul style="list-style-type: none">• Check cable connections and restart the control unit; if the fault persists, contact the dealer or EOS service.

If any other unidentified error messages appear, please contact EOS service. Make sure to supply the serial number, fault details and other relevant information.

The “switch-off” rocker switch

The control unit is equipped with a “switch-off” rocker switch.

You will find this switch on the left side of the main relay box.

This switch allows to switch the control unit to standby mode (notice the heating will not start), to switch the control unit completely off (disconnect from power) or to switch the control unit off, but to leave the light switched on.



rocker switch



Attention! Parts of the printed circuit board will still remain energized in the switched off condition! Risk of electric shock!

Notice!

When switching the “switch-off” rocker switch from Pos. I to Pos. II, you will be at the intermediate position 0 for approx. 1s.

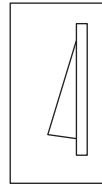

Default Position

Switch setting 0

Press the switch on the lower side of the rocker to the first latch (**switch setting 0**). The switch will be in the middle position. The unit is now completely switched off (disconnected).

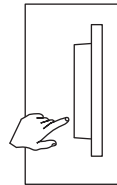

Device switched off (completely);
Position 0.

Switch setting II

To turn the light on in the cabin while the unit is still disconnected (for maintenance and cleaning work) push the left side of the rocker to the second latch (**switch setting II**).



Light enabled;
Device switched off.
Position II.

Switch setting I

To make the unit ready for operation, switch back to the initial position (**switch setting I**). The unit will return to standby mode.



Device switched on.
Position I.



Recycling

Devices or lighting elements that will not be used any longer have to be handed in at a recycling station according to regulation 2012/19/EU. Do not dispose it with the normal household waste.



Service Address:

EOS Saunatechnik GmbH
Schneiderstriesch 1

35759 Driedorf, Germany

Tel: +49 (0)2775 82-514

Fax: +49 (0)2775 82-431

servicecenter@eos-sauna.de

www.eos-sauna.de

Please retain this address together with the installation guide for further references.

To help us answer your questions quickly and competently please provide the information printed on the type shield including the model, item no. and serial no., in all inquiries.

Equipment commissioning date:

Stamp and signature of the authorized electrician:

General Terms and Conditions of Service

I. Scope

Unless otherwise agreed in writing in a specific case, these terms and conditions of service shall apply to service operations, including examining and repairing complaints. All our existing or future legal relationships shall be governed solely by the following terms and conditions of service. Our recognition of any conflicting terms and conditions of the Ordering Party shall be conditional upon our having given our express written consent to their applicability. We hereby expressly object to any terms and conditions of the Ordering Party contained in its General Terms and Conditions of Business or order confirmation. If order confirmations or deliveries are accepted without reservation, this shall not be deemed to constitute recognition of such terms and conditions. Any ancillary agreements or amendments must be confirmed in writing.

II. Costs

The Ordering Party shall bear the following costs in connection with the service operation:

- De-installation/installation and electrical works (connection / disconnection).
- Transportation, postage and packaging.
- Function testing and troubleshooting including inspection and repair costs.

There shall be no third-party billing.

III. Obligations / Ordering Party's cooperation

The Ordering Party shall provide free-of-charge assistance to the manufacturer in carrying out the service operation.

In the case of a warranty claim the manufacturer shall provide the required replacement parts to the Ordering Party free of charge.

IV. Service visit by the manufacturer

In the event that it is essential that a manufacturer employee carry out the service operation on site, this must be agreed in advance. Where the main reason for the service call is not the fault of the manufacturer, any costs incurred shall be recharged to the Ordering Party after the service visit and shall be paid as per agreed payment terms.

V. Liability

The manufacturer shall assume liability in accordance with the currently applicable statutory regulations. The packaging for all of our products is designed for the shipping of individually packed goods (pallet). We expressly

point out that our packaging is not suitable for individual shipments via parcel post. The manufacturer shall accept no liability for damage incurred as a result of improper packaging in an individual shipment.

VI. Manufacturer's Guarantee

The manufacturer's guarantee shall apply only in the event that installation, operation and maintenance have been carried out in accordance with the manufacturer's specifications contained in the installation instructions and instructions for use.

- The guarantee period shall commence from the date on which proof of purchase is provided and shall be limited, in principle, to 24 months.
- Guarantee services shall be performed only if the original proof of purchase relating to the equipment can be presented.
- Any and all guarantee claims shall become void if modifications are made to the equipment without the manufacturer's express consent.
- Any guarantee claim shall likewise become void in the case of defects that arise due to repairs or interventions made by unauthorized persons or due to improper use.
- In the case of guarantee claims, the serial and article numbers must be indicated together with the product name and a meaningful description of the fault.
- This guarantee shall cover defective equipment parts, with the exception of usual wear parts. Wear parts are, among others, lamps, glass parts, heating elements and sauna stones.
- Only original replacement parts may be used within the warranty.
- Service visits by outside companies shall require a written order to be issued by our service department.
- The equipment in question shall be sent to our service department by the Ordering Party and at its expense.
- Electrical installation and connection works in the event of service or replacement shall be carried out at the Customer's expense and shall not be borne by the manufacturer.

Complaints in respect of our products shall be reported to the responsible authorized dealer and shall be exclusively handled via the latter.

The manufacturers General Terms and Conditions of Business, which can be found at www.eos-sauna.com/agb, shall apply in addition to the foregoing terms and conditions of service.

As of 08/2018