

Sol-Tec II SL

Brine Nebulization System



EN Installation and operation manual



Table of contents

1	About this manual / general	5
1.1	Scope of applicability.....	5
1.2	Target group.....	5
1.3	Symbols used.....	5
1.4	Warranty.....	6
1.5	Further information	7
2	Safety.....	8
2.1	Intended use.....	8
2.2	Safety notices.....	8
2.2.1	Handling of chemicals, risks to humans and the environment	8
2.2.2	Protective measures and rules of conduct	8
3	Product description - scope of delivery.....	9
3.1	Scope of delivery / accessories.....	9
3.2	Product description	11
3.3	Identification of the device / nameplate.....	11
3.4	Technical data.....	12
3.5	Transport / storage	12
4	Assembly.....	13
4.1	Select the installation site	13
4.2	Assembly instructions (installation suggestion)	13
4.3	Mechanical assembly.....	14
4.4	Hydraulic assembly.....	17
4.5	Electric assembly.....	18
5	Commissioning.....	19
5.1	Commissioning - comments.....	19
5.2	Commissioning - procedures.....	19
5.2.1	Disinfection and flushing of the Sol-Tec II SL.....	21
5.2.1.1	Attaching the brine container on the SOL-TEC II SL SL	24
5.2.1.2	Activate disinfection.....	25
5.2.2	Activate flushing	27
6	Operation / service	29
6.1	General	29
6.2	Control - software.....	29
6.3	The main menu	32
6.3.1	Main menu Login.....	33
6.4	Menu Operation modes.....	34

6.4.1	Operation mode Continuous dosing.....	35
6.4.2	Operation mode Button operation.....	38
6.4.3	Operation mode External control	41
6.5	Settings menu.....	44
6.5.1	System menu	44
6.5.1.1	Language	45
6.5.1.2	Date + time	45
6.5.1.3	Display + Backlight	46
6.5.1.4	Reset.....	47
6.5.1.5	User settings / password assignment	48
6.5.1.6	EOS Menu 1	49
6.5.1.7	EOS Menu 2.....	49
6.5.1.8	Log files	50
6.5.2	Dosing menu.....	50
6.5.3	Effect illumination and Sound menu.....	51
6.6	Service menu.....	52
6.6.1	Test menu Inputs	53
6.6.2	Test menu Outputs	53
6.6.3	Carry out disinfection	54
6.6.4	Information menu.....	54
6.7	Login.....	55
6.8	Logout.....	55
6.9	Optional functions	55
6.10	Refill consumables	55
7	Maintenance, care, faults	56
7.1	Device maintenance.....	56
7.2	Regular water check	56
7.3	Fault removal / Error codes.....	56
8	Decommissioning - storage - disposal	59
8.1	General	59
9	Documents.....	60
9.1	Terminal diagrams	60
9.2	Commissioning protocol / instruction	62
9.3	Operation data sheet.....	63
9.4	Maintenance protocol	65
9.4.1	Disinfection protocol.....	66
9.5	Spare parts list, wear parts list, list of consumables.....	67
10	Appendices	68

Imprint:

All rights reserved

© Copyright by EOS – EOS Saunatechnik GmbH

Edition: see footer

Reproduction of any kind and translation into other languages, even in excerpts, are only permitted with the express authorisation of the company EOS - EOS Saunatechnik GmbH

Subject to technical modifications

These operating instructions are an English translation of the original German version by the company EOS.

Responsible for the content:

Co. EOS - EOS Saunatechnik GmbH

Schneiderstriesch

D-35759 Driedorf

Phone:+49 (0) 2775 / 82 - 0

Fax:+49 (0) 2775 / 82 - 431

Email: info@eos-sauna.de

1 About this manual / general

1.1 Scope of applicability

This manual describes the function, assembly, commissioning and operation of the nebulization station type Sol-Tec II SL with the corresponding accessories.

Read these operating instructions carefully prior to the operation and maintenance and keep them in close proximity of the device for immediate use!

1.2 Target group

This system may only be operated by our authorised partners and persons instructed in the device functions after they have read and understood these operating instructions.

Electrical connection work may only be carried out by appropriately trained specialists!

1.3 Symbols used

This document uses the following types of safety notices as well as general notices:



DANGER!

"DANGER" denotes a safety notice whose non-observance may result in immediate, **serious** or **life-threatening injuries** or **significant property damages!** This includes danger caused by **electrical voltage!**



CAUTION!

"CAUTION" denotes a safety notice whose non-observance may result in **bodily injury, damage to health** or **property damages!**



ATTENTION!

"ATTENTION" denotes a safety notice whose non-observance may result in **property damages!**



CAUSTIC !

"CAUSTIC" denotes a safety notice whose non-observance when handling chemicals may result in **bodily injury** or **property damages**.



ESD SENSITIVE !

"ESD SENSITIVE" denotes electronic components that may be damaged by electrostatic discharge. When handling the devices, the generally known safety precautions for ESD-sensitive devices must be observed!



HINT !

A "HINT" denotes information that may result in improvements in the operating process.

1.4 Warranty

All devices and systems of the Co. EOS are manufactured using state-of-the-art manufacturing methods and are subject to a comprehensive quality control. However, should there be a reason for complaint, any compensation claims shall be directed to the company EOS in accordance with the general terms and conditions of warranty (see below).

General terms and conditions of warranty

The Co. EOS assumes a 2-year warranty, starting with the commissioning, up to 27 months after delivery; subject to correct installation and commissioning with a completed and signed commissioning protocol.

Exempt from this are wear parts such as gaskets, hoses, membranes, dosing screws, electrodes, roller supports and other parts that are subject to mechanical or chemical wear and tear. For these we assume a warranty of 1/2 year.

Our merchandise management programme requires an invoice for each delivery (including warranty services). When returning a defective component, upon review you will receive a corresponding credit, if applicable. We request a return within 14 days.

The costs for subsequent damages and for the processing of warranty claims are excluded.

There are no warranty claims for damages that were caused by frost, water and electrical overvoltage or by improper handling.



HINT!

In order to protect the warranty claims, please mail the completed commissioning protocol, along with the defective component, to the Co. EOS. Without the completed maintenance protocol, we reserve the right to assert a warranty regulation.



ATTENTION!

It is not permitted to make any modifications to the device. Any violation of this provision voids the warranty obligation as well as the product liability!

1.5 Further information

Further information about special topics, e.g., description of the operating parameters, and additional support is available from your specialist supplier.

2 Safety

2.1 Intended use

The brine nebulization station Sol-Tec II SL may only be used for the purpose listed in the product description under *Section 3.2!* In this context, all locally applicable provisions (e.g., UVV [Accident Prevention Regulation], DGUV [German Social Accident Insurance] for prevention of accidents, occupational safety and protection of drinking water) must be observed!

2.2 Safety notices

Carefully read and comply with the operating instructions prior to assembly and use of the device!

Work on the device and changes in the settings may only be carried out by properly trained and instructed persons! It is of particular importance to comply with the rules for occupational safety and accident prevention and to wear protective clothing.

2.2.1 Handling of chemicals, risks to humans and the environment



CAUTION!

Important information regarding the handling of chemicals can be found in the chemicals manufacturers' safety data sheets!

When handling chemicals, protective clothing must be worn!

In case of emergency when handling chemicals, please contact the Poison Control Centre! In Germany, for example:

Emergency telephone number:

Poison Control Centre Munich (or any other poison control centre)

Phone: +0049 89 19240

2.2.2 Protective measures and rules of conduct



CAUTION!

It is not permitted to make any modifications to the device!

3 Product description - scope of delivery

3.1 Scope of delivery / accessories

The brine nebulization station type Sol-Tec II SL consists of a mounting plate and a floor-standing compressor. It contains the following individual components:

1. Micro/processor control SSD + BET inside the housing
2. 1 or 2 hose dosing pumps
3. Mounting plate with console for brine politainer
4. Pressure monitoring
5. Stainless steel nozzle with plastic cover shield, wall bushing and 5m PTFE dosing line
6. Disinfection set with disinfection tablet, mixing container and nozzle adapter
7. Sterile brine solution in the politainer
8. Compressor

The following optional accessories are available:

- Button plate with flush-mounted box
- Second dosing nozzle and hose pump for cabins with a base area larger than 35m²
- Stainless steel nozzle shield

Overview Sol-Tec II SL

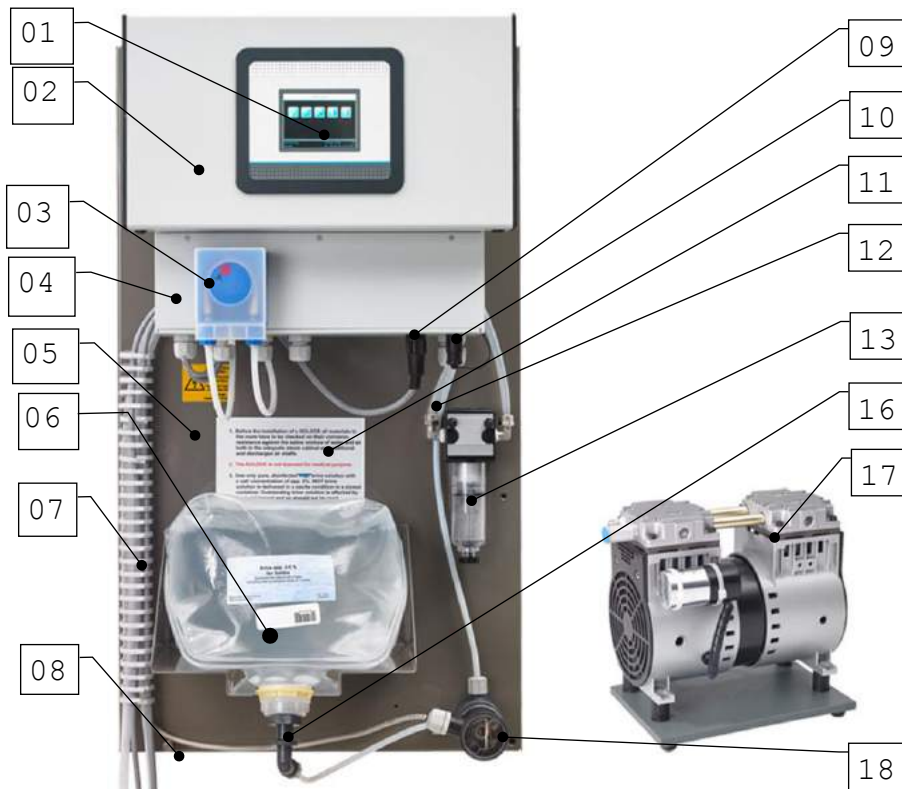
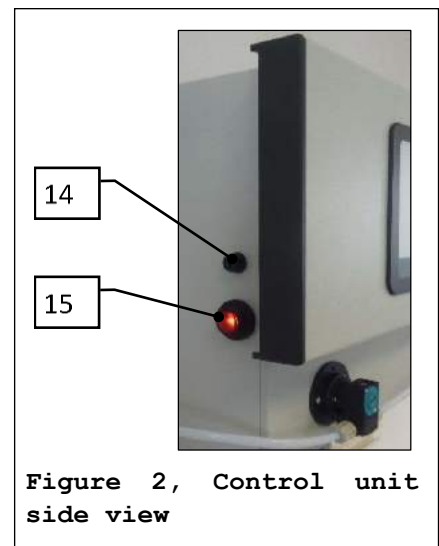

Figure 1, Brine nebulization station type Sol-Tec II SL

- 01 Touch display
- 02 Control housing
- 03 Hose pump
- 04 Pump lid
- 05 Mounting plate
- 06 Brine politainer
- 07 Cable routing
- 08 Earth connection
- 09 Socket for compressor connection
- 10 Socket for button connection
- 11 Safety notices
- 12 Hose connection to the nozzle component
- 13 Water separator
- 14 Main fuse
- 15 Main switch
- 16 Plug-in canister connection
- 17 Compressor
- 18 Pressure switch



3.2 Product description

The brine nebulization device type Sol-Tec II SL is used to create a saline ocean climate in dry rooms, such as saunas, tepidaria and relaxation rooms.

With the aid of the Sol-Tec II SL, an atomised brine solution is sprayed into the cabin. After a short time, the room will be filled with a saline climate. The system contains various setting parameters and can thus easily be adapted to its site of use and the framework conditions. The brine is extracted from a plastic container by means of a hose pump. The politainer is sealed off from the atmosphere and collapses during the extraction, which prevents a contamination of the brine solution with bacteria. By means of a hose pump, the brine solution is transported to the two-component atomiser nozzle. There, the brine is atomised with the aid of pressurised air and blown into the cabin.

The device is operated via a 3.2" touch display with an operating unit and three freely selectable operation modes. Continuous dosing, button operation and external control, including weekly programme. A special disinfection programme for disinfecting is available.



ATTENTION!

The Sol-Tec II SL is not medically approved!

3.3 Identification of the device / nameplate

Copy the data from your device's nameplate here!

Field 1: Enter serial number

Field 2: Enter date of manufacturing

Field 1: Serial number: _____
Field 2: Date of manufacturing: _____
Figure 3, Nameplate Sol-Tec II SL

3.4 Technical data

	Sol-Tec II SL	
Article no.	24532, 24533	
Dimensions and weights:		
External dimensions	47x71x24cm (WxHxD)	
Space requirements, incl. compressor operation and maintenance	100x200x100cm (WxHxD)	
Empty weight/operating weight	Approx. 20kg or 21kg, respectively	
Connection data		
Electric connection data	230V, AC, 50Hz, 0,4kW, safety (Schuko) plug	
Hydraulic connection data	---	
Required duct connection	---	
Protection class	IP44	
Nominal pressure / operating pressure	PN 16 / max. 11barÜ	
Operating data:		
Brine volume in the politainer	1kg or 5kg corresponds to 1l or 5l, respectively	
Dosing performance brine	Approx. 75ml/min	
Medium temperature	5°C to 35°C	
Ambient temperature	5°C to 35°C	
Humidity engineering room	Max. 70%	
Degree of saturation of the brine fog	Max. 5% at the nozzle exit	
Ventilation (in and out)	Recommended in the engineering room	
Software version	---	
Hardware version	V1.1	

3.5 Transport / storage

Please check the device immediately upon receipt for potential transport damage.



ATTENTION!

The device may be damaged by frost or high temperatures. Avoid exposure to frost during transport and storage! Do not store the device next to objects with strong heat emission or in direct sunlight. The device may only be transported and stored in its original packaging. Please ensure careful handling.

4 Assembly

4.1 Select the installation site

The installation site must have the following properties:

1. The device must be protected from direct sunlight.
2. An electrical power connection with an earthing contact is required.
3. Sufficient ventilation and aeration in the installation room must be ensured.

4.2 Assembly instructions (installation suggestion)

The mounting plate of the Sol-Tec II SL is installed on a wall in the engineering room. The compressor is positioned on the floor below the mounting plate. Please take into consideration the required space for operation and maintenance of the device.



ATTENTION :

The Sol-Tec II SL is not suited for outdoor installation!

All components and materials used in the cabin as well as the air intake and outlet ducts must be resistant to the brine concentration in the cabin.

Prior to the assembly, the following tasks must be carried out:

- Attach warning and notice signs in accordance with the locally applicable accident prevention regulations (Germany: GUV-V D05) at the designated positions.
- Prior to the installation of a SOL-TEC II SL, all materials in the cabin and the ventilation lines must be checked for their corrosion resistance to a 5% brine solution!
- Only use highly pure, disinfected EOS brine with a maximum salt content of 5%!

Assembly diagrams

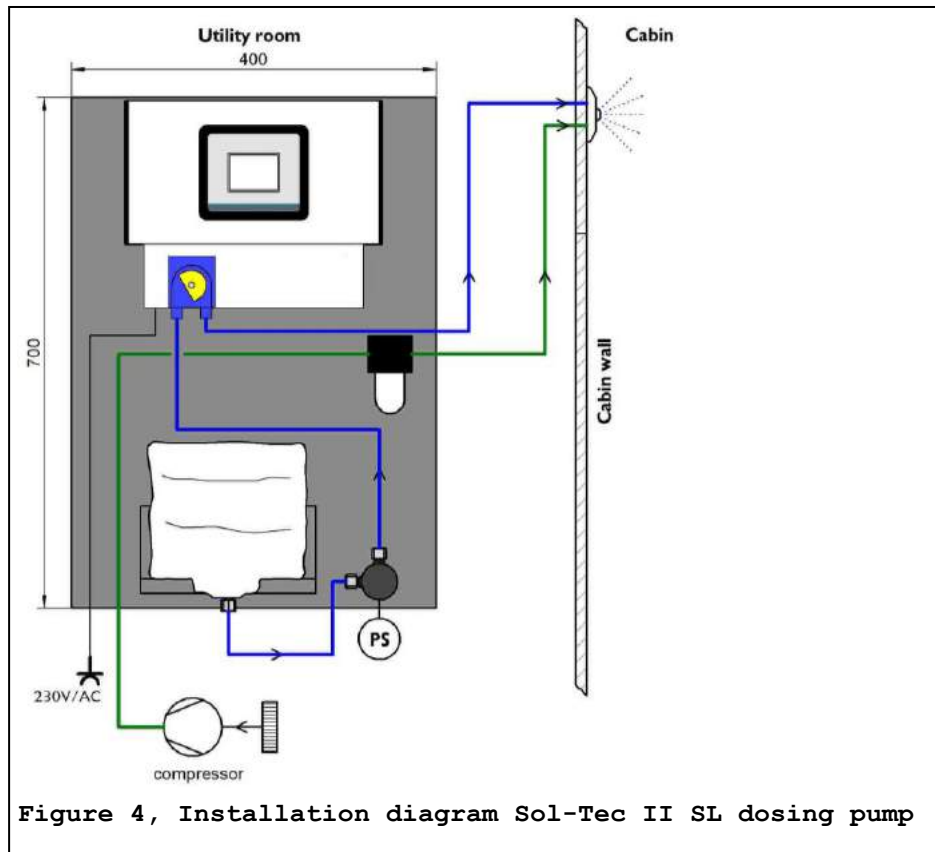

4.3 Mechanical assembly

Assemble the nebulization station

The nebulization station Sol-Tec II SL should be installed in an easily accessible location in the engineering room.

Securely attach the mounting plate on the wall with 4 screws and ensure easy accessibility. It is best to place the included compressor on the floor below the mounting plate.

Assemble the brine dosing nozzle

For the installation of the nozzle component and the wall bushing, drill an opening with a diameter of approx. 100 mm through the cabin wall (see *Figure on the following page*). The drill hole should be located about 20-30 cm from the cabin ceiling. The drill hole should be located as far as possible from the air outlet. The bushing is glued into the drill hole in a diffusion-proof manner. During the final assembly, the gasket ring of the nozzle shield must sit flush on the wall bushing.

During the final assembly, the hose lines are led through the wall bushing from the direction of the nebulization station and attached to the nozzle shield's hose connectors. The nozzle shield is then placed on the wall bushing and fixed with the enclosed screws.

The nozzle shield, nozzle receptor with nozzle and hose connections is supplied as a pre-assembled unit.

Nozzle shield wall bushing

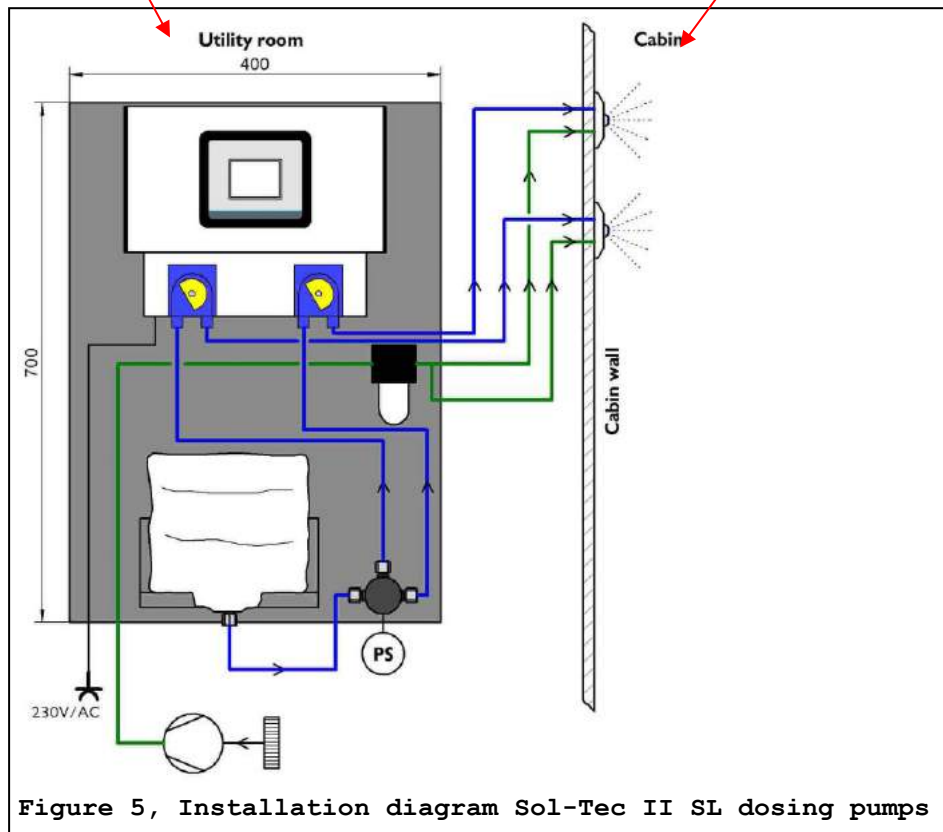

Figure 5, Installation diagram Sol-Tec II SL dosing pumps

Figure 6, Assembly of the nozzle component

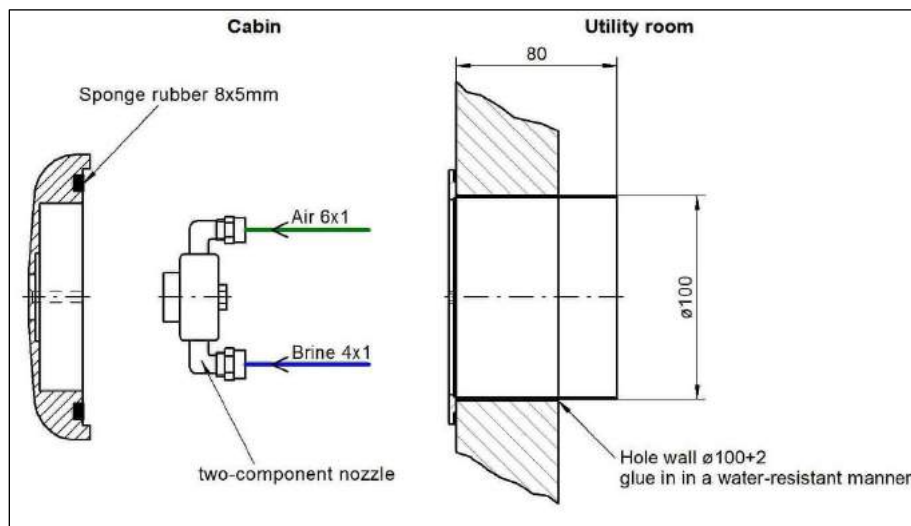

Figure 7, Installation drawing wall bushings with nozzle shield

Connection of the hose lines to the two-component nozzle

When connecting the hose lines, please ensure that the pressurised air line and the brine dosing line are not switched!

- Brine line = PTFE line 4x1mm
- Pressurised air line = PE line 6x1mm

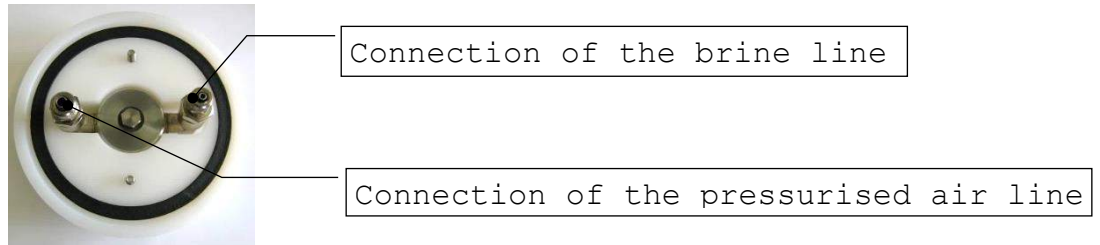

Figure 8, Two-component nozzle with shield



ATTENTION!

Do not kink the dosing lines during the installation toward the cabin! Should this occur during the installation, it is imperative to install a new dosing line!

Ensure that the lines can move freely toward the back, for the potential dismantling of the nozzle.

Assemble the button (optional)

For the assembly of the button, a flush-mounted cover is recommended. The button and the flush-mounted cover can be ordered optionally. During assembly, the cover is fixed in the wall and sealed against the cabin lining. Should an empty conduit be installed for the button cable, select an empty conduit with an interior diameter of 25 mm. During the installation, please ensure that the bending radius does not fall below a minimum value of 30cm. Finally, insert the plug-in-ready button cable and plug it in. The following shows the dimensions for the buttons and flush-mounted covers:

The button plate is attached to the flush-mounted cover / wall with 4 screws. See Figure

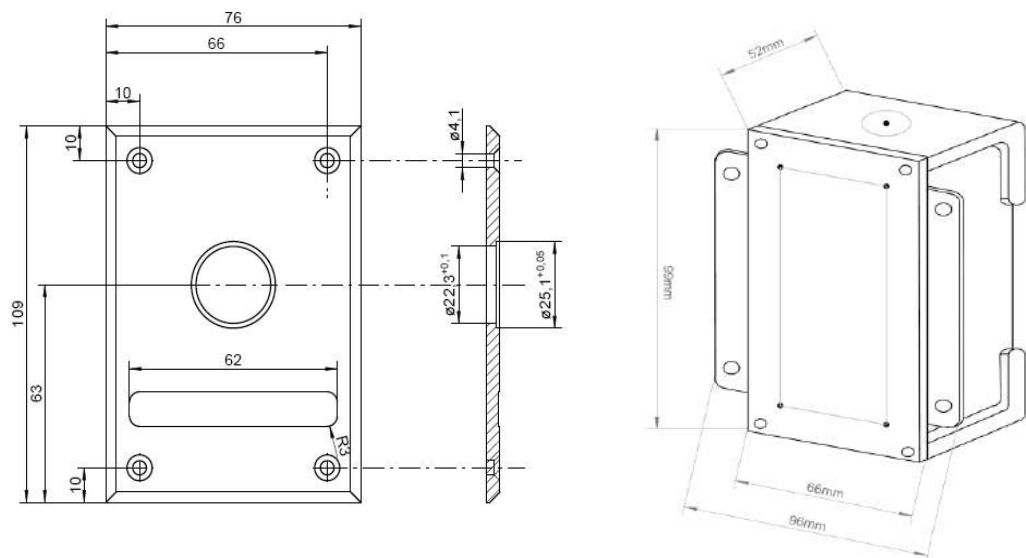



ATTENTION!

Seal the button plate with a suitable sealant against the cabin wall to prevent any moisture from entering behind the button plate!

4.4 Hydraulic assembly

Install the dosing line and the air line from the nozzle component to the nebulization station and connect this to the water separator or the hose pump, respectively.

When connecting the dosing line to the pump's hose transitions, first unscrew the hose transition's union nut from the pump. Then push the union nut and the clamp ring over the hose. Push the hose on the connection nipple and attach it by firmly tightening the union nut.

Connect the compressor to the water separator by means of the enclosed air hose.



ATTENTION!

The length of the dosing line affects the length of the pump's runtime for the disinfection. Therefore, note the length of the installed hose in the disinfection protocol under *Section 9.4.1*. The hose length is required for the commissioning.



DANGER FROM ELECTRIC VOLTAGE !

For all electrical work, the power supply must be switched off!



ATTENTION !

The electronic components in the control housing of the Sol-Tec II SL are sensitive to electrostatic discharge. When handling the devices, the generally known safety precautions for ESD-sensitive devices must be observed.

The following applies, in particular:

- Do not pull or plug in socket connections under voltage.
- As the person handling the device, please discharge yourself electrostatically for at least 5 seconds prior to directly touching the devices, e.g., by touching a grounded part of the system or by wearing an ESD antistatic wrist strap connected to ground.

Assembly

- Electric wiring: See circuit diagram and terminal diagram under Section 9.1, *Terminal diagrams*.

Connection of the external control signal "Effects for light and sound" according to the enclosed terminal diagram.

Additional work for the connection to an external control centre (BCS)

Connection of the potential-free collective fault signal to the BCS (Building Control System) according to the enclosed terminal diagram.

5 Commissioning

5.1 Commissioning - comments

The work described here may only be carried out by appropriately trained specialist personnel from a specialist company. Alternatively, the work can be carried out by persons who have read and understood the entire operating instructions. Prior to commissioning, the installed systems must be checked for proper installation and leaks.

Please use the commissioning protocol from *Section 9.2* for the commissioning.

The device comes loaded with factory-defined settings. During the commissioning, adjust the control parameters to the desired mode of operation and enter them in the operation data sheet under *Section 9.3*.

5.2 Commissioning - procedures

Insert the roller support at the fragrance pump

1. Remove the clipped-on, transparent pump cover and the blue safety disc (32). Pull the hose bracket (33) from the guide in the housing.

31. Transparent pump cover (not shown)
32. Safety disc
33. Hose bracket with dosing hose made of Viton (hose set)
34. Roller support (not visible)
35. Pump housing
41. Suction connection
42. Pressure connection

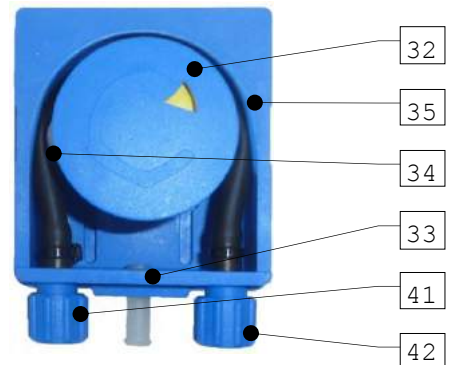

Figure 9, Hose pump

2. Push the yellow roller support onto the axle.



Figure 10,
Insert roller support



Figure 11,
Insert the hose bracket

3. Insert the hose bracket into the housing's guides until it firmly snaps into place.

4. Turn the roller support counter-clockwise while carefully pushing the hose inside the housing until the entire hose is contained in the housing.



Figure 12,
Turn roller support

Now replace the safety disc and the transparent pump cover. This completes the assembly of the roller support.

For dismantling the roller support and the hose bracket, please proceed in the reverse sequence.

Plug the safety plug in a corresponding socket and turn on the device at the main switch.



ATTENTION!

For the initial commissioning, the length of the dosing line must be entered and saved at the touch panel.

In order to do this, log on with your password as Technician 2 in user level 3. (Procedure see Section 6.3.1).

Open the menu **Settings** → **Dosing** and enter the actually installed hose length at the display.

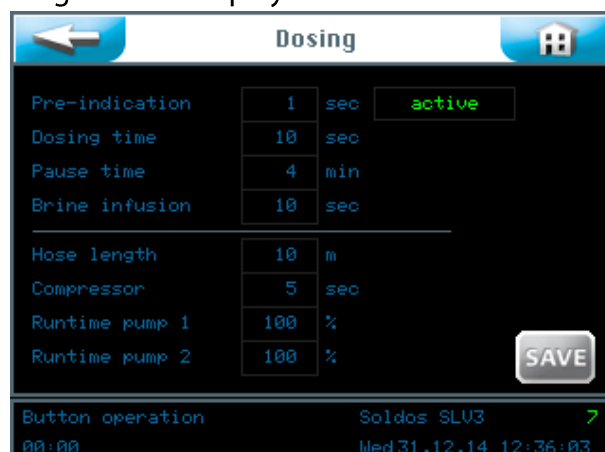

Save your entries with the **SAVE** button.

For the initial commissioning and after a down time of more than 28 days **always start with an initial disinfection.**

Please use the commissioning protocol from *Section 9.2, Commissioning protocol* for the commissioning.

5.2.1 Disinfection and flushing of the Sol-Tec II SL

The scope of delivery for each new brine politainer includes a disinfection tablet.

Check the **correct date** on the display and set it if necessary! See *Section 6.5.1.2.*

The disinfection should preferably be carried out after or prior to operating the system, when no visitors are present in the cabin.



CAUTION!

Prior to the start of the disinfection, it must be ensured that nobody is present in the cabin during the disinfection. The nozzle adapter (19) with hose is connected to the dosing nozzle in the cabin so that any exuding liquid can be caught in a container or guided directly to the drain.

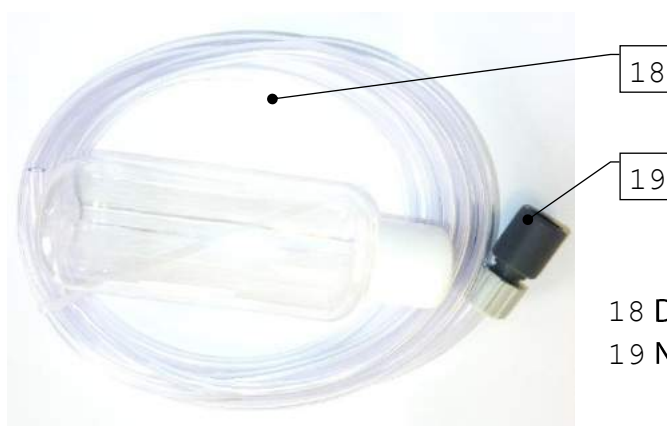

18 Disinfection set complete
19 Nozzle adapter (inlet)

Figure 13, Disinfection set (18)



ATTENTION!

Enter each disinfection in the disinfection protocol under *Section 9.4.1.*

1. Call up the disinfection via **Menu** → **Service Menu** → **Disinfection**.



Press the upper **Start** button.

Follow the menu navigation



2. Fill the enclosed empty bottle in the disinfection set (18) with water. The required amount of disinfection solution depends on the length of the dosing line from the nebulization device to the nozzle in the cabin wall. Per each started 10m line length, 200ml of disinfection solution are required. For example, for a line length of 11m, 400ml of disinfection solution are required.

- Fill the bottle with water (equals 200ml), add one of the enclosed disinfection tablets SOL-TEC II SL, article no. 19871 and shake the bottle until the tablet dissolves.



HINT!

When the device is delivered, the politainer is already connected to protect it from contamination.

- Unscrew the politainer lid and fill the empty politainer with the disinfection liquid from the bottle. Repeat this process until the required amount of disinfection solution has been prepared.



3. Reconnect the politainer filled with disinfection solution and attach it on the console. To do this, follow the procedure described in the following section.



HINT!

For dosing, use a salt brine with a maximum concentration of 5%!

Connect the politainer

1. Remove the politainer from the console and unscrew the original lid from the politainer.

2. Pull the politainer connection for SOL-TEC II SL from the suction line's nipple.

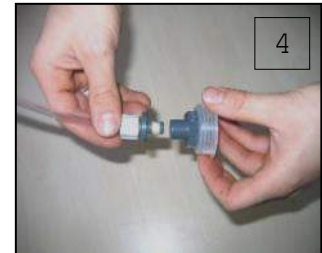

3. Screw the politainer connection onto the politainer.



4. Insert the suction line with the nipple in the politainer connection.



5. Turn the connected container upside down and push it into the console. Ensure that the yellow flange ring rests in the slot intended for this purpose.



5.2.1.2 Activate disinfection



1. Connect the nozzle adapter (19) of the enclosed disinfection set (18) to the nozzle in the corresponding cabin and catch the exuding disinfection solution in a plastic container or guide it directly to the floor drain.



CAUTION!

Make sure that no persons are present in the affected cabin.

2. Press the button to activate the disinfection.
3. The hose pump starts up and the disinfection solution is transported through the entire system.

The disinfection time is displayed.



The residence time (11m) is displayed.



After the expiration of the residence time, the disinfection is completed. In the event of a fault message, the disinfection must be repeated.



- After successful disinfection, empty the remaining disinfection solution from the brine politainer, rinse it and save for the next disinfection.
- Connect a new, unused brine politainer with a 5% brine solution to the dosing line. See *Section 5.2.1.1, Attaching the brine container on the SOL-TEC II SL SL*.
- Press the **OK** button. The programme step Flushing follows automatically.



Follow the menu navigation by pressing **OK**.

The dosing pump starts up and the brine is transported through the entire system.



The flushing time is displayed.



The flushing is completed.

In the event of a fault message, the flushing must be repeated.

- After successful flushing, remove the nozzle adapter (19) on the nozzle in the respective cabin.
- It is recommended to clean the cabin afterwards.
- The device is now properly disinfected and flushed and thus operational.

All flushing and disinfection actions are recorded in the data logger.

5.2.2 Activate flushing

If you would like to carry out a flushing without disinfection, proceed as follows. Call up the flushing via Menu → Service Menu → Disinfection.



Press the **lower** button to start the flushing.



Follow the menu navigation by pressing .





- Make sure that **no persons are present in the affected cabin!**
- Connect the nozzle adapter (19) of the enclosed disinfection set (18) to the nozzle in the corresponding cabin and catch the exuding disinfection solution in a plastic container or guide it directly to the floor drain.
- Confirm with the **OK** button.

The dosing pump starts up and the flushing solution is transported through the entire system.



The flushing time is displayed.



The flushing is completed.

In the event of a fault message, the flushing must be repeated.

- After successful flushing, remove the nozzle adapter (19) on the nozzle in the respective cabin.
- It is recommended to clean the cabin afterwards.
- The device is now operational.

All flushing and disinfection actions are recorded in the data logger.

6 Operation / service

6.1 General

The work described here may only be carried out by appropriately trained and instructed personnel. Alternatively, the work may be done by operating personnel who have read and understood the entire operating instructions and are familiar with the device.

Once all preparations for the commissioning have been completed, the operation can be started.



CAUTION!

To protect against germs and bacteria, always carry out an initial disinfection for the commissioning and in the event of a down time of more than 28 days, as described under Section 5.2.1, *Disinfection and flushing of the Sol-Tec II SL*, and document it.

It is irrelevant how long the device was in operation during this time.

6.2 Control - software

The control of the Sol-Tec II SL is operated via the touch display on the front of the device.

External control signals (e.g., buttons) and the fault message can be connected to the control circuit board inside the housing, as needed.



Figure 15, Control unit

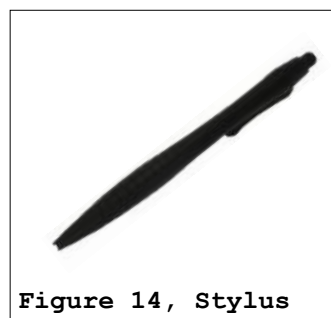

Figure 14, Stylus

For easier operation and to protect the touch display, a stylus is part of the scope of delivery.

Menu structure of the control

Overview main menu

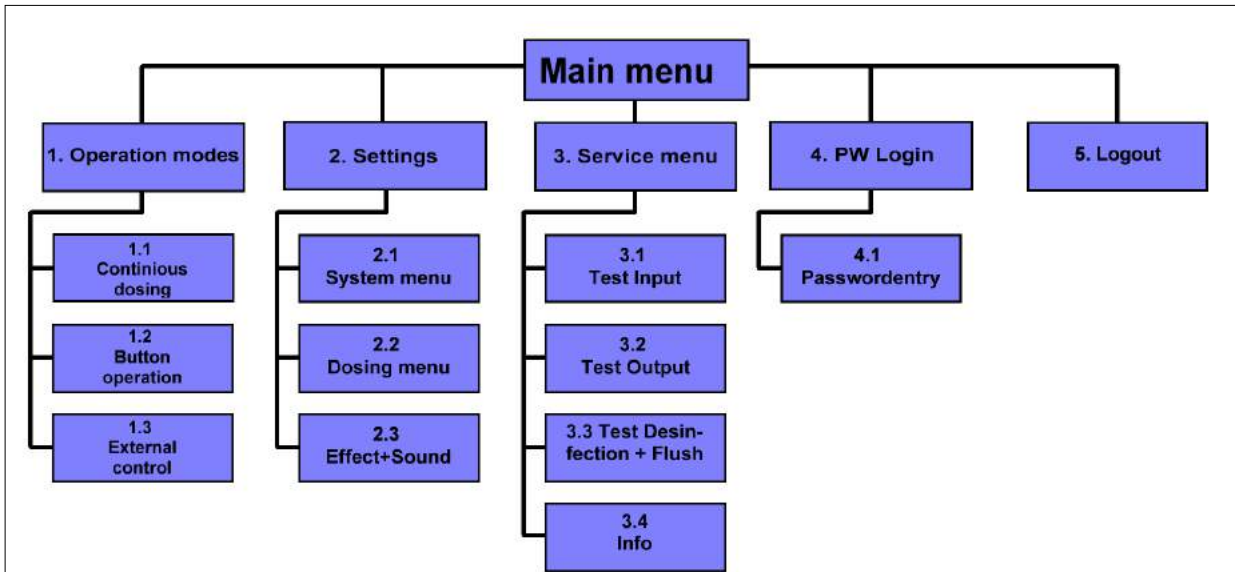

Figure 16, Main menu overview

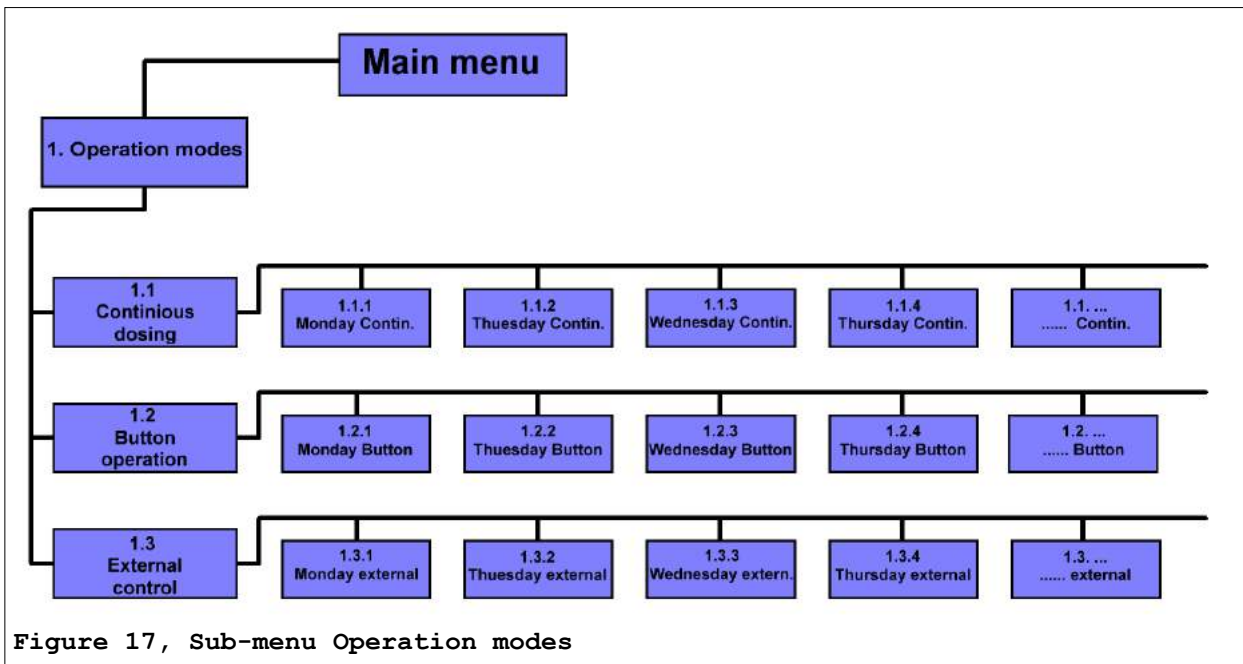

Figure 17, Sub-menu Operation modes

Sub-menu Operation modes

Sub-menu Settings

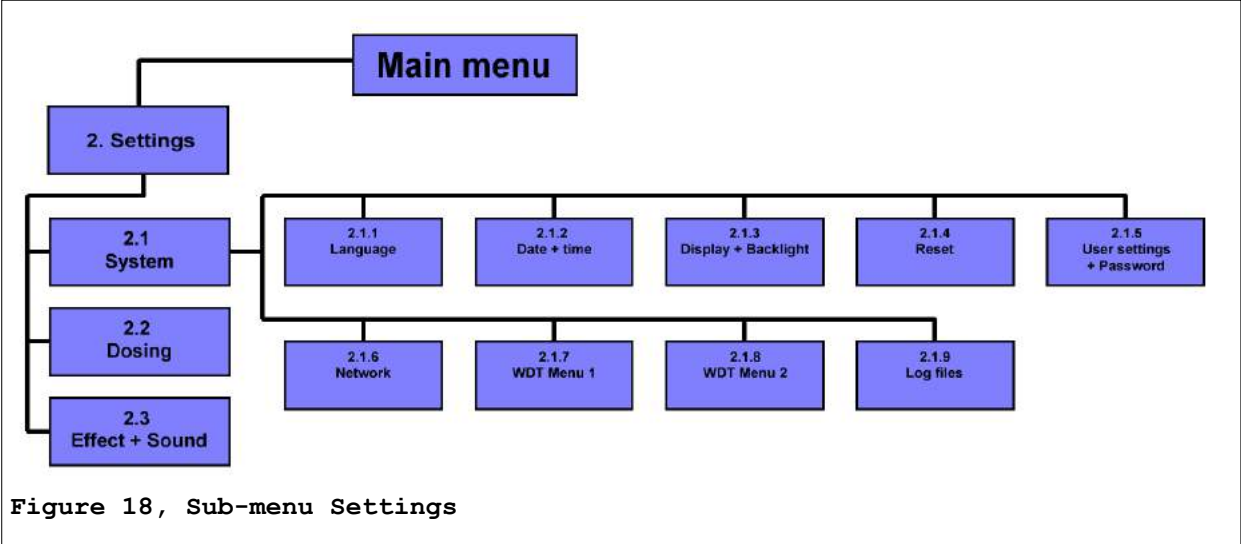

Figure 18, Sub-menu Settings





6.3 The main menu

After activating the device with the main switch located on the side, you will see the main menu.

In the main menu, you can choose between 5 main groups.



Symbols used

1.  Operation modes
2.  Settings
3.  Service menu
4.  Login, to the various authorisation levels
5.  Logout from the authorisation levels. Successful logout is denoted by the "0" in the information bar!

The information bar



The information bar is always displayed at the bottom edge of the screen. It displays the following information.

- a. Display of the operation mode; e.g., button operation
- b. Device designation; Sol-Tec II SL

- c. Level of user rights; 0-5
- d. 00:00; countdown until the next dosing; time display
- e. Weekday, date, time

The navigation field



When you touch the entry field, the font colour changes to white and the navigation field appears automatically. Use the arrow keys to set the desired values and confirm with **OK**.

Use **SAVE** to save the values and **ESC** to terminate the entry.

6.3.1 Main menu Login

Before you can adjust the device settings, you must log on at the device.

Touch the Login button  in the main menu to enter the password for the desired user level.



There are several user levels for setting the control, from 0-7.

User level 0	Visitor	Read-only
User level 1	Final customer	limited modifications
User level 2	Technician 1	more complex modifications
User level 3	Technician 2	more complex modifications
User level 4	Network administrator	access for factory customer service
User level 5	Reset password	access for service partners
User level 6	EOS Menu 1	access for factory customer service
User level 7	EOS Menu 2	access for factory customer service



HINT!

You can find the pre-set passwords in the operation data sheet under *Section 9.3*.

After successful login, the respective user level is shown in green in the display's information bar. You can now adjust the desired control settings.

When you are finished adjusting the settings, use the Logout button  to log off again. See also *Section 6.8*.

Automatic Logout:

After the adjustable delay time, the display will switch to the screen saver. One minute later, the screen saver will be dimmed and an automatic Logout to User level 0 occurs.

If you wish to adjust additional settings, you must log on again.

6.4 Menu Operation modes

The operation modes



Symbols used



Back button

Touch the Back button to return to a previous user level.



Home button

Touch the Home button to navigate to the Start menu.

You can choose between 3 operation modes:

1. Operation mode Continuous dosing
2. Operation mode Button operation
3. Operation mode External control

The green border indicates which operation mode has been selected.

6.4.1 Operation mode Continuous dosing

With the operation mode Continuous dosing you can set 2 time blocks for each day of the week.



Start operation mode Continuous dosing



Adjust settings for Continuous dosing



Confirm the information text with **OK**.



In the right-hand column, you can use the corresponding button to switch each individual weekday to **active** or to deactivate it.

In the left-hand column, touch the respective weekday to enter the start times and the corresponding parameters.

The cycle menu for each weekday



This displays the empty input mask. You can enter 2 different time periods with the corresponding parameters. During these time periods, the adjusted Continuous dosing will be active in the dry room.



HINT!

A pause of at least 30 minutes must be between the time blocks! An incorrect entry is marked with a red frame around the field **Start.**

The earliest Start time you can set is 00:01! The latest Start time you can set is 23:30! Otherwise, it may overlap with the next day.



When you touch the entry field, the font colour changes to white and the navigation field appears. Set the desired values and save your entry with **OK**.

Save your entries with the **SAVE** button.

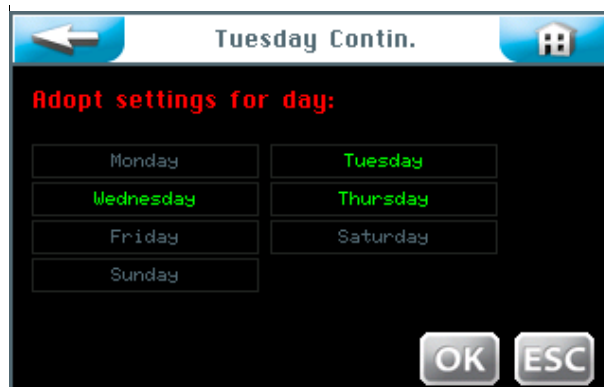

The control will now ask you if you want to adopt the settings for other days, as well. Mark in green all days for which you would like to adopt the settings and confirm your selection with **OK**.

Adopt values; confirm with **OK** or terminate with **ESC**.

Use the button  to return to the previous display. (Repeated memory query)

6.4.2 Operation mode Button operation

Use the operation mode Button operation to determine on which weekdays and at what time of day the visitors in the sauna cabin can start the dosing.



Start the operation mode Button operation



Adjust settings for Button operation



Confirm the information text with .

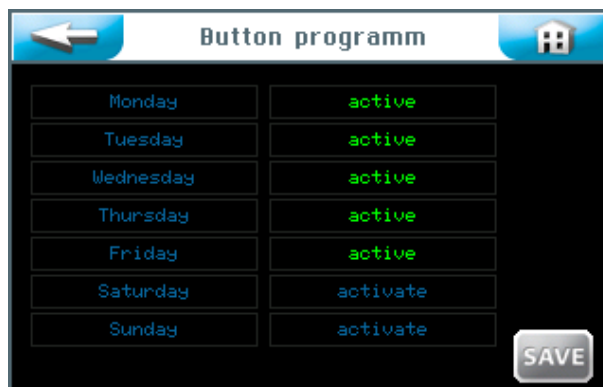

In the right-hand column, you can use the corresponding button to switch each individual weekday to or to deactivate it.

In the left-hand column, touch the respective weekday to enter the start times and the corresponding parameters.

The button menu for each weekday

no	Start	Stop	Cycle
1	--:--	--:--	10
2	--:--	--:--	10

This displays the empty input mask. You can enter 2 different time periods with the corresponding parameters. During these periods, the buttons in the sauna cabin will be active.



HINT!

A pause of at least 30 minutes must be between the time blocks! An incorrect entry is marked with a red frame around the field **Start.**

The earliest Start time you can set is 00:01! The latest Start time you can set is 23:30! Otherwise, it may overlap with the next day.

no	Start	Stop	Cycle
1	--:--	--:--	10
2	--:--	--:--	10

When you touch the entry field, the font colour changes to white and the navigation field appears. Set the desired values and save your entries.

In the **Cycle** column, you can set the cycle length in minutes in which the device will process the set dosing and pause times. Upon expiration of this time interval, the device stops; after a delay time, it can be started again via the button.

Save your entry with **OK**.

Once you have finished your entry, save the values with the **SAVE** button.

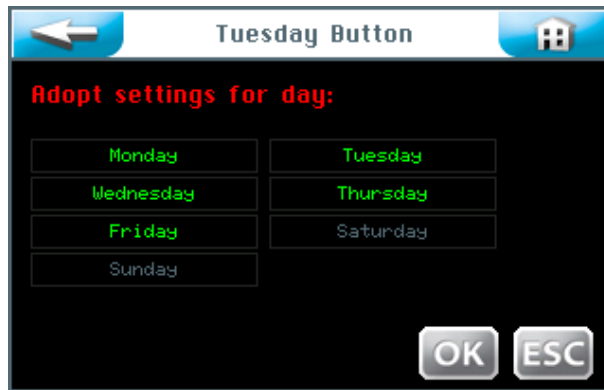

The control will now ask you if you want to adopt the settings for other days, as well. Mark in green all days for which you would like to adopt the settings and confirm your selection with **OK**.

Adopt settings; confirm with **OK** or **ESC**.

Use the button  to return to the previous display. (Repeated memory query)

6.4.3 Operation mode External control

Use the operation mode External control to set time blocks. During these time blocks, the operation of the Sol-Tec II SL will be controlled by an external system, e.g., via a EOS central control. You can set 2 time blocks for each day of the week. The Sol-Tec II SL will only react to the input signal during these time blocks.



Start operation mode External control



Adjust settings for operation mode External control

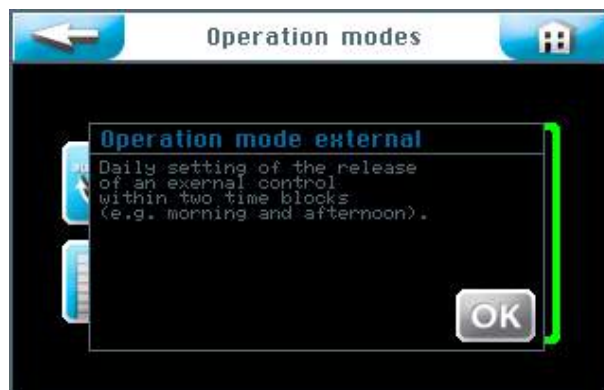

Confirm the information text with .



In the right-hand column, you can use the corresponding button to switch each individual weekday to **active** or to deactivate it.

In the left-hand column, touch the respective weekday to enter the start and stop times.

The time settings for each weekday



This displays the empty input mask. You can enter 2 different time blocks with the corresponding parameters. During these time periods, the external control will be active.



HINT!

A pause of at least 30 minutes must be between the time blocks! An incorrect entry is marked with a red frame around the field **Start.**

The earliest Start time you can set is 00:01! The latest Start time you can set is 23:30! Otherwise, it may overlap with the next day.



When you touch the entry field, the font colour changes to white and the navigation field appears. Set the desired values and save your entry with **OK**.

Once you have finished your entry, save the values with the **SAVE** button.

The control will now ask you if you want to adopt the settings for other days, as well. Mark in green all days for which you would like to adopt the settings and confirm your selection with **OK**.

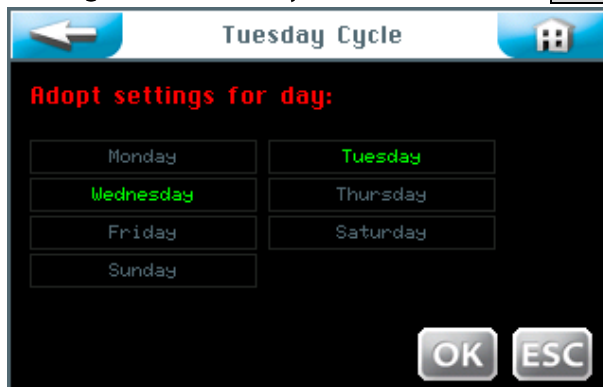

Adopt values; confirm with **OK** or terminate with **ESC**.

Use the button  to return to the previous display. (Repeated memory query)

6.5 Settings menu

Use this menu to adjust the settings for System, Dosing, as well as Effect and Sound.

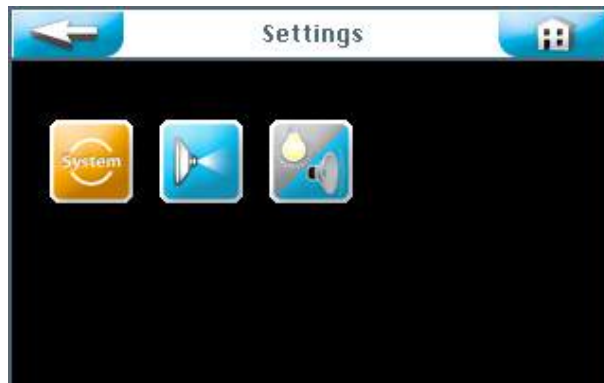

You can choose between 3 setting groups on the touch screen:

1. System menu
2. Dosing
3. Effect + Sound

Use the button  to return to the previous user level.

6.5.1 System menu



You can choose between 9 functions on the touch screen:

1. Language
2. Date + time
3. Display and Backlight
4. Reset
5. User settings / password assignment
6. Network
7. EOS Menu 1
8. EOS Menu 2
9. Log files

Use the button  to return to the previous user level.

6.5.1.1 Language

Select the desired language.



Confirm with **OK** or terminate with **ESC**.

Use the button  to return to the previous display.

6.5.1.2 Date + time

Use the arrow keys to set the desired date and time. Save and finish your entries with the **SAVE** button.

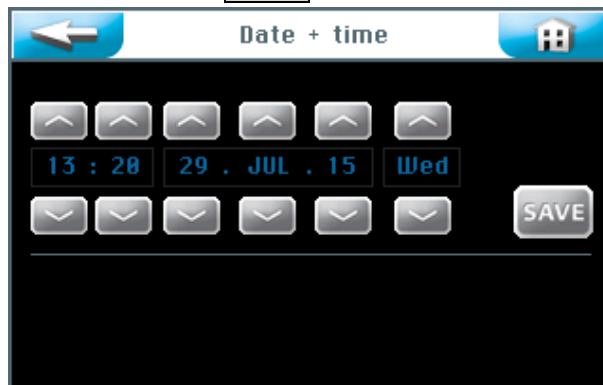

Use the button  to return to the previous user level.



HINT!

The time must be manually adjusted to summer or winter time!

Here, you can adjust the settings for the display and the buttons. When you touch the touch display, the display switches to the full **Display brightness**. After the selected **Delay**, the display will switch to the screen saver. One minute later, the screen saver will be adjusted to the value **Display dimmed** and an automatic Logout to User level 0 occurs.

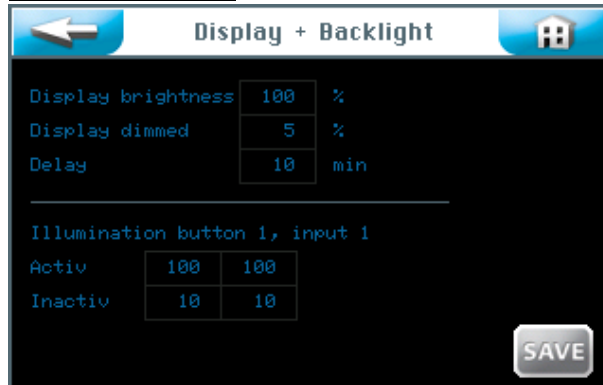

You can adjust the button illumination in % for activated and inactive buttons or for external input.

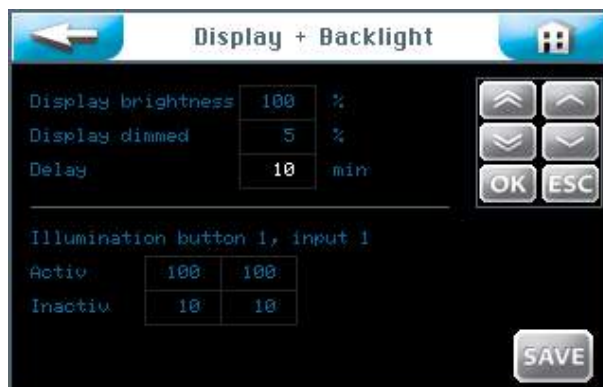

When you touch the entry field, the font colour changes to white and the navigation field appears. Set the desired values and save your entries.



HINT!

Enter the set values in the operation data sheet under Section 9.3. The factory settings can also be found in the operation data sheet.

Once you have finished your entry, save the data with the **SAVE** button. Adopt values; confirm with **OK** or terminate with **ESC**.

Use the button  to return to the previous display. (Repeated memory query)

If you want to reset the control to the factory settings, use the **Reset** button in the System menu.

The factory settings can be found in the operation data sheet under *Section 9.4*.



The reset to the factory settings depends on the user level at which you are logged on. (Factory settings, see operation data sheet under *Section 9.4*.)

In the **User levels 2 and 3**, the values of the following menu sections will be reset to the factory settings:

Button operation, Display + Backlight, Infusion as well as Pre-indication and Furnace

In **User level 5**, in addition to User level 3 all passwords for user levels 1-4 will be reset.

In **User level 6**, the settings for time and weekdays will also be reset.

In **User level 7**, the product name and serial number will be reset, as well as time and date.

In **User level 4**, the network settings will be reset.



Confirm your selection with **OK** in order to reset the software to the factory settings, or terminate the process with **ESC**.

Here, you can change the passwords for the different user levels. You can find the pre-set passwords in the operation data sheet *under Section 9.3*.



Select which password you wish to change.

User level 1	Final customer	password must contain 4 characters
User level 2	Technician 1	password must contain 5 characters
User level 3	Technician 2	password must contain 6 characters
User level 4	Network administrator	password must contain 7 characters



Enter the respective password and confirm the entries with **OK**.

If the display changes back to "System menu" after the last entry, the password was changed successfully. The selected user level will be displayed in green in the information bar.



HINT!

Enter the changed password in the operation data sheet!

Network

This function is currently not active.



6.5.1.6 EOS Menu 1

In this menu, the user has read-only authorisation. Changes may only be carried out by the EOS factory customer service.



6.5.1.7 EOS Menu 2

In this menu, the user has read-only authorisation. Changes may only be carried out by the EOS factory customer service.

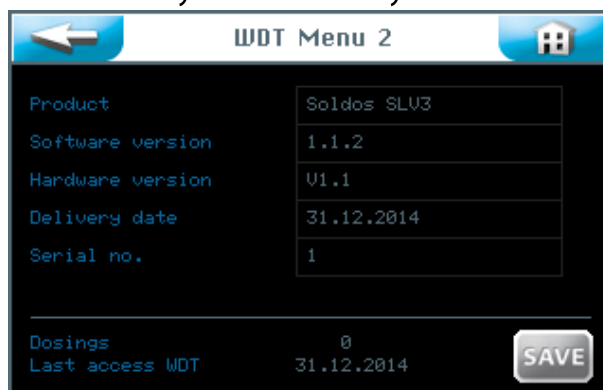

6.5.1.8 Log files

In the log files, the last 255 events in the software are registered. Faulty events are displayed in red.

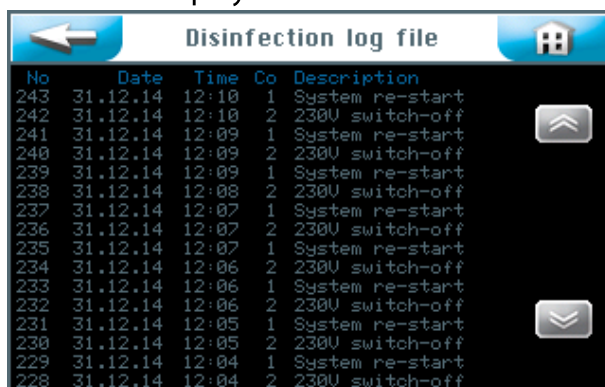

No	Date	Time	Co	Description
243	31.12.14	12:10	1	System re-start
242	31.12.14	12:10	2	230V switch-off
241	31.12.14	12:09	1	System re-start
240	31.12.14	12:09	2	230V switch-off
239	31.12.14	12:09	1	System re-start
238	31.12.14	12:08	2	230V switch-off
237	31.12.14	12:07	1	System re-start
236	31.12.14	12:07	2	230V switch-off
235	31.12.14	12:07	1	System re-start
234	31.12.14	12:06	2	230V switch-off
233	31.12.14	12:06	1	System re-start
232	31.12.14	12:06	2	230V switch-off
231	31.12.14	12:05	1	System re-start
230	31.12.14	12:05	2	230V switch-off
229	31.12.14	12:04	1	System re-start
228	31.12.14	12:04	2	230V switch-off

6.5.2 Dosing menu

In the Dosing menu, the parameters for the brine dosing can be adjusted.



Pre-indication	1	sec	active
Dosing time	10	sec	
Pause time	4	min	
Brine infusion	10	sec	
Hose length	10	m	
Compressor	5	sec	
Runtime pump 1	100	%	
Runtime pump 2	100	%	

Button operation Soldos SLU3 >
00:00 Wed 31.12.14 12:37:13

Pre-indication:

Here, you can set the time for the pre-indication of an actuator (e.g., light) prior to a brine dosing. Pre-indication means that an actuator will be controlled in order to announce a pending brine infusion to the sauna visitor. You can also deactivate the pre-indication.

Dosing time:

Duration of the brine dosing

Pause time:

Pause between two dosing repetitions

Brine infusion:

Duration of a mist dosing that was triggered via a button operation. (only possible in the operation mode Continuous dosing)

Hose length:

Length of the installed dosing hose from the nebulization device to the misting nozzle

Compressor:

Compressor runtime

Runtime pump 1:

Setting of the pump runtime in percent

Runtime pump 2 (optional, with a 2nd installed pump):

Setting of the pump runtime in percent

In order to adjust settings, please touch the number fields.

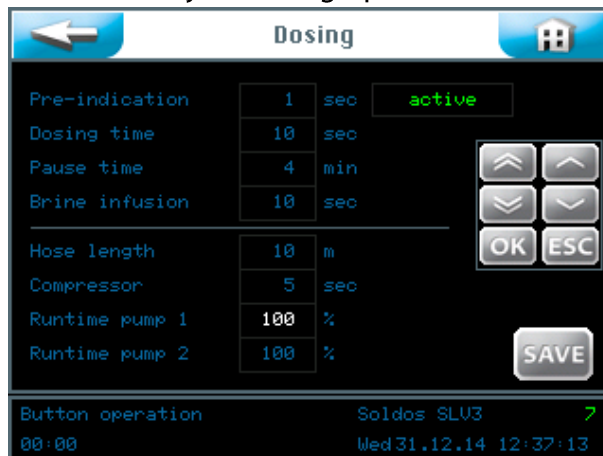

When you touch the entry field, the font colour changes to white and the navigation field appears. Set the desired values and save your entries. Adopt values; confirm with **OK** or terminate with **ESC**.

Use the button  to return to the previous display. (Repeated memory query)

6.5.3 Effect illumination and Sound menu

In the main menu, touch **Settings** → **Effect+Sound**.

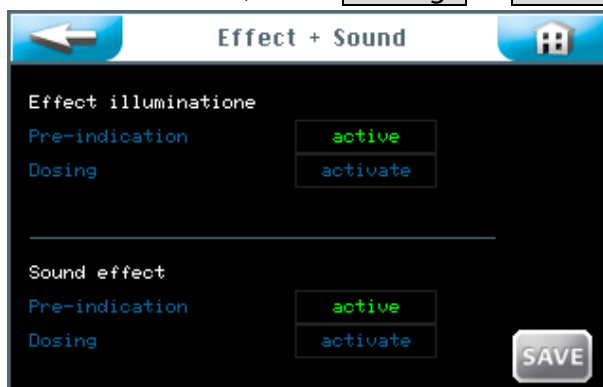

Effect illumination:

Use this signal to control an illumination effect during the dosing pre-indication and / or during the dosing. The effect illumination can be activated for the pre-indication and / or the dosing.

Pre-indication:

Lead time until the dosing. The time is adopted by the setting Pre-indication in the Dosing menu, *see Section 6.5.2*.

Dosing:

Dosing duration; the time is adopted by the setting Dosing time in the Dosing menu, *see Section 6.5.2*.

Sound effect:

Use this signal to control a sound effect during the dosing pre-indication and / or during the dosing. The sound effect can be activated for the pre-indication and / or the dosing.

Pre-indication:

Lead time until the dosing. The time is adopted by the setting Pre-indication in the Dosing menu, *see Section 6.5.2*.

Dosing:

Dosing duration; the time is adopted by the setting Dosing time in the Dosing menu, *see Section 6.5.2*.

Once you have finished your entries, save the data with the **SAVE** button. Adopt values; confirm with **OK** or terminate with **ESC**.

Use the button  to return to the previous display. (Repeated memory query)

6.6 Service menu

In the Service menu, function tests can be conducted for the actuators and the control. These are also used to search for errors. The Service menu also includes device information.



You can choose between 4 Service menus on the touch screen:

1. Test menu Inputs
2. Test menu Outputs
3. Carry out disinfection
4. Information menu

6.6.1 Test menu Inputs

With this function, you can test 3 electric inputs of the control.

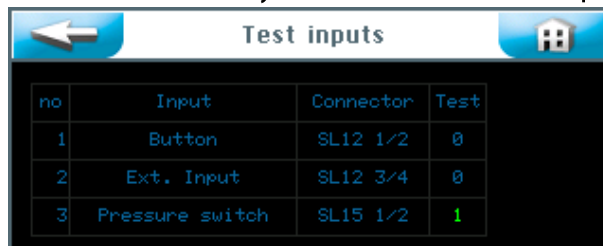

no	Input	Connector	Test
1	Button	SL12 1/2	0
2	Ext. Input	SL12 3/4	0
3	Pressure switch	SL15 1/2	1

The Test column displays the actual state at the respective input. Select the desired test line and start it in the Test column.

If the input is open, no electric signal is present and a will be displayed.

If the input is closed, an electric signal is present and a green appears.

Explanation:

Button: A signal from the button is present (only when Button operation is active).

Ext. input: A signal from an external unit is present. (e.g., from the EOS central control)

Pressure switch: A signal from the pressure switch is present.

SL12 1/2: Number of the terminal and number of the terminal strip on the circuit board.

6.6.2 Test menu Outputs

With this function, you can test the electric outputs of the control.

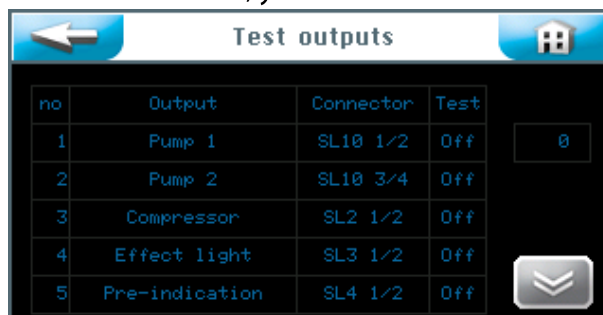

no	Output	Connector	Test
1	Pump 1	SL10 1/2	Off
2	Pump 2	SL10 3/4	Off
3	Compressor	SL2 1/2	Off
4	Effect light	SL3 1/2	Off
5	Pre-indication	SL4 1/2	Off

Select the desired test line and start it with the button.

Test no. 1 to 5

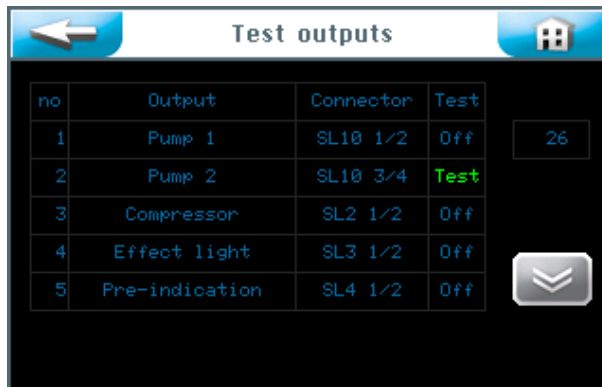

no	Output	Connector	Test
1	Pump 1	SL10 1/2	Off
2	Pump 2	SL10 3/4	Test
3	Compressor	SL2 1/2	Off
4	Effect light	SL3 1/2	Off
5	Pre-indication	SL4 1/2	Off

In the field, **Test** will be displayed in green letters and the clock counts down from 30 seconds to 0.

During this time, an electric signal is present at the output. If a consumer is connected to the respective output, this will start for 30 seconds.

Press the **Test** button to terminate the test.

Test no. 6 to 10

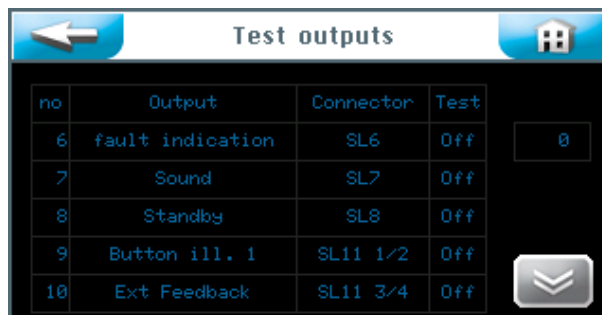

no	Output	Connector	Test
6	fault indication	SL6	Off
7	Sound	SL7	Off
8	Standby	SL8	Off
9	Button ill. 1	SL11 1/2	Off
10	Ext Feedback	SL11 3/4	Off

6.6.3 Carry out disinfection

See Section 5.2.1, *Disinfection and flushing of the Sol-Tec II SL*

6.6.4 Information menu

Touch the **Info** button in the Service menu to display device data.



Product	Soldos SLU3
Software version	1.1.2
Hardware version	V1.1
Delivery date	31.12.2014
Serial no.	1
Installed pumps	2
Werner Dosiertchnik GmbH & Co. KG	
Hettlinger Str. 17	
86637 Wertingen	
www.werner-dosiertchnik.de	
Button operation	Soldos SLU3
00:00	Wed 31.12.14 12:40:00

6.7 Login

See *Section 6.3.1*.

6.8 Logout

Touch the **Logout** button in the main menu to switch to User level 0 (Operation level). The display in the information bar changes to 0.



Automatic Logout:

After the adjustable delay time, the display will switch to the screen saver. One minute later, the screen saver will be dimmed and an automatic Logout to User level 0 occurs.

If you wish to adjust additional settings, you must log on again.

6.9 Optional functions

- Light effects
- Sound effects
- Collective fault message

Further information about these topics is available from your specialist supplier.

6.10 Refill consumables

Refill salt brine:

See *Section 5.2.1, Disinfection and flushing of the Sol-Tec II SL*

7 Maintenance, care, faults

7.1 Device maintenance

It is recommended to commission a specialist firm with the regular maintenance.

In order to ensure the proper function of the Sol-Tec II SL, observe the following points:

1. Disinfection and maintenance according to the maintenance protocol under *Section 9.4*.



CAUTION!

Disinfect during each politainer change, or at least every 28 days!

2. Empty the water separator during each politainer change.
3. Regular cleaning of the device. Brine water leaves unattractive stains and corrodes metal if it is not wiped away.
4. Stocking of the required consumables

7.2 Regular water check

Not required

7.3 Fault removal / Error codes



HINT!

It is also possible that switches or sensors are faulty and thus do not transmit any electric signals.

During a disruption in the device, the dosing is interrupted.

Fault messages:

For the removal of fault messages, see the following fault table.

Message 1: Disinfection pre-indication

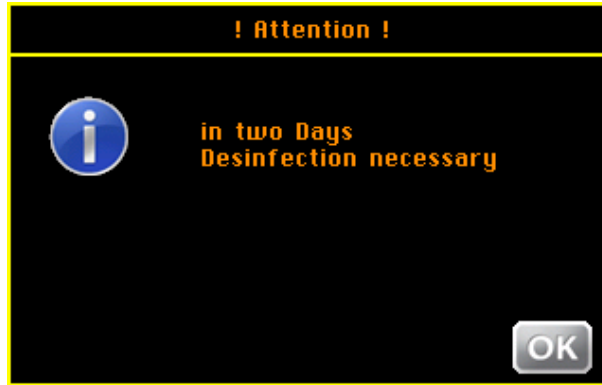

Pre-indication for the disinfection. You can already carry out the disinfection. The pre-indication is repeated after 1 day.

Message 2: Disinfection necessary



Carry out the disinfection.

Message 3: Disinfection failed, politainer empty



Message 4: Communication fault!



Fault table

Fault display	Effect	Cause / measures
Message 1: Disinfection advance warning	<ul style="list-style-type: none"> no effect, display only 	<ul style="list-style-type: none"> Disinfection can be carried out
Message 2: Disinfection necessary	<ul style="list-style-type: none"> no effect, display only 	<ul style="list-style-type: none"> Carry out disinfection
Message 3: Fault message, Disinfection failed, politainer empty	<ul style="list-style-type: none"> Disinfection cannot be completed 	<ul style="list-style-type: none"> Insufficient disinfectant, carry out new disinfection with a larger amount of disinfectant
Message 4: Fault message, Communication fault	<ul style="list-style-type: none"> Communication fault between display circuit board and control circuit board 	<ul style="list-style-type: none"> Switch off the device at the main switch and switch it on again after 5 seconds
Lack of water disinfection (Disinfection mode)	<ul style="list-style-type: none"> Disinfection is terminated 	<ul style="list-style-type: none"> Insufficient disinfection solution in the politainer / repeat the disinfection
No clean spraying pattern	<ul style="list-style-type: none"> faulty spraying pattern 	<ul style="list-style-type: none"> Dirty nozzle Compressor defective Water separator leaks Check system for leaking seals Pump defective
The device cannot be switched on	<ul style="list-style-type: none"> Main fuse F0 defective Main switch defective Power supply interrupted 	<ul style="list-style-type: none"> Replace fuse Replace main switch Check power supply
System without function	<ul style="list-style-type: none"> incorrect setting Main fuse F1 Control circuit board defective 	<ul style="list-style-type: none"> Check settings / reset Replace main fuse F1 Replace control circuit board
Effect illumination without function	<ul style="list-style-type: none"> Fuse for effect illumination defective incorrect setting 	<ul style="list-style-type: none"> Replace fuse Check settings
Pre-indication without function	<ul style="list-style-type: none"> Fuse for pre-indication defective incorrect setting 	<ul style="list-style-type: none"> Replace fuse Check settings
1 dosing pump without function	<ul style="list-style-type: none"> Fuse defective Dosing pump defective 	<ul style="list-style-type: none"> Replace corresponding fuse Replace dosing pump
Button illumination without function	<ul style="list-style-type: none"> Fuse defective 	<ul style="list-style-type: none"> Replace fuse
No dosing	<ul style="list-style-type: none"> Fuse defective Dosing pump defective Nozzle clogged 	<ul style="list-style-type: none"> Check fuse Check pump / replace Check nozzle / clean / replace
incorrect time of day	<ul style="list-style-type: none"> Power interruption for more than 20 days Buffer condenser defective 	<ul style="list-style-type: none"> Reset time of day. Replace circuit board

8 Decommissioning - storage - disposal

8.1 General

Decommissioning

In the event of decommissioning, the device must be emptied completely!

Deactivate the device at the main switch for a decommissioning of a maximum of 28 days.

For a decommissioning of more than 28 days, remove the brine politer and replace it with a new one upon recommissioning. Clean out all lines by blowing air through them.

Disposal of used parts and operating materials

Thoroughly clean any dismantled, contaminated parts prior to disposal.

Used parts and operating materials must be disposed of according to the regulations applicable at the site of operation or they must be recycled. If operating materials are subject to special regulations, please observe the corresponding information on the packaging. In case of doubt, information is available at your local institution responsible for disposal or from the manufacturing company.

If this is not possible, dispose as hazardous waste.

9 Documents

9.1 Terminal diagrams

Notice for terminal diagrams: The special terminal diagrams attuned to the optimal furnishing of the brine sprayer 1kg and 5kg are located near the device's control cabinet.

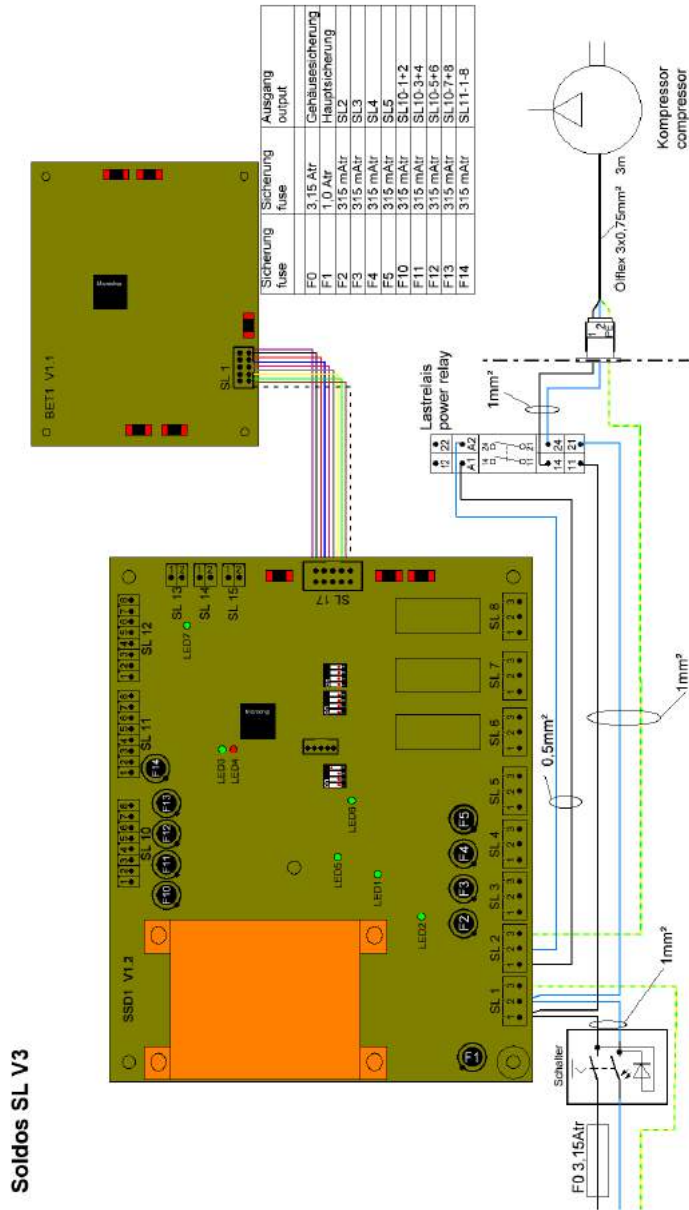



Soldos SL V3

Ausgänge / output

SL 1
 230V
 Spannungsversorgung
 power supply

SL 2
 230V max. 60W
 Kompressor
 compressor **Achtung!**
Lastrelais
Attention!
power relay

SL 3
 230V max. 60W
 Effektbeleuchtung
 effect lighting

SL 4
 230V max. 60W
 Voranmeldung
 pre-indication

SL 5
 230V max. 60W
 ohne Funktion
 without function

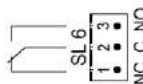
SL 6
 p-free (8A 230V/AC)
 Störmeldung
 fault indication

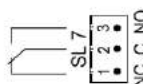
SL 7
 p-free (8A 230V/AC)
 Soundeffekt
 Sound

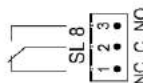
SL 8
 p-free (8A 230V/AC)
 ohne Funktion
 without function

Ausgänge / output

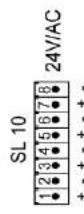
SL 10
 24V/AC
 8)
 7)
 6)
 5)
 4) GND Solepumpe 2
 birne solution pump 2
 3) + Solepumpe 2
 birne solution pump 2
 2) GND Solepumpe 1
 birne solution pump 1
 1) + Solepumpe 1
 birne solution pump 1

Ausgänge / output

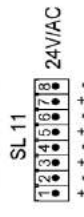
SL 11
 24V/AC
 8) GND
 7) +
 6) GND
 5) +
 4) GND
 3) +
 2) GND Beleuchtung Taster 1
 illumination push-button 1
 1) + Beleuchtung Taster 1
 illumination push-button 1

Eingänge / input

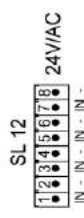
SL 12
 24V/AC
 8) GND
 7) IN
 6) GND
 5) IN
 4) GND externe Ansteuerung
 external control contact
 3) IN externe Ansteuerung
 external control contact
 2) GND Taster Duft / push-button 1
 1) IN Taster Duft / push-button 1

Eingänge / input

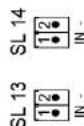
SL 13
 2) GND reserve
 1) IN reserve

SL 14
 2) GND reserve
 1) IN reserve

SL 15
 24V/AC
 2) GND Druckschalter
 pressure switch
 1) IN Druckschalter
 pressure switch

Druckschalter
 pressure switch

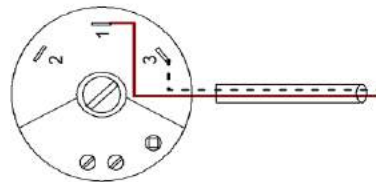

SL15/ 1 + 2

9.2 Commissioning protocol / instruction

This protocol is to be completed by the maintenance technician! Without a completed and signed commissioning protocol, all warranty claims become void!

The commissioning protocol is included with the attached documents.

9.3 Operation data sheet



HINT!

During the commissioning, enter the operating parameters in the operation data sheet!

Settings menu	Factory setting	Setting ranges	Step	during commissioning	Optimised during operation
				Date:	Date:
Display and Backlight					
Display brightness	100%	5-100%	1		
Display dimmed	5%	5-100%	1		
Delay	10 minutes	10-60 minutes	1		
Background lighting Button 1 active / inactive	100% 10%	0-100% / 0-100%	1		
Background lighting Button 2 active / inactive	100% 10%	0-100% / 0-100%	1		
Password assignment					
Password Visitor	no password	---			
Password Final customer	0123	0000-9999			
Password Technician 1	01234	00000-99999			
Password Technician 2	012345	000000-999999			
Dosing					
Pre-indication time	1 seconds	1-60 seconds	1		
Pre-indication active / activate	activate	active / activate			
Dosing time	10 seconds	5-60 seconds	1		
Pause time	4 minutes	1-15 minutes	1		
Brine infusion	10 seconds	5-60 seconds	1		
Hose length	10m	5-30m	1		
Effect illumination + sound					
Pre-indication effect illumination	activate	active/activate	---		
Dosing effect illumination	activate	active/activate	---		
Pre-indication sound	activate	active/activate	---		
Dosing sound	activate	active/activate	---		

Operation data sheet, --master copy--

Settings menu	Factory setting	Setting ranges	Step	during commissioning	Optimised during operation
				Date:	Date:
Display and Backlight					
Display brightness	100%	5-100%	1		
Display dimmed	5%	5-100%	1		
Delay	10 minutes	10-60 minutes	1		
Background lighting	100%	0-100% /	1		
Button 1 active / inactive	10%	0-100%			
Background lighting	100%	0-100% /	1		
Button 2 active / inactive	10%	0-100%			
Password assignment					
Password Visitor	no password	---			
Password Final customer	0123	0000-9999			
Password Technician 1	01234	00000-99999			
Password Technician 2	012345	000000-999999			
Dosing					
Pre-indication time	1 seconds	1-60 seconds	1		
Pre-indication active / activate	active	active / activate			
Dosing time	10 seconds	5-60 seconds	1		
Pause time	4 minutes	1-15 minutes	1		
Brine infusion	10 seconds	5-60 seconds	1		
Hose length	10m	5-30m	1		
Effect illumination + sound					
Pre-indication effect illumination	activate	active/activate	---		
Dosing effect illumination	activate	active/activate	---		
Pre-indication sound	activate	active/activate	---		
Dosing sound	activate	active/activate	---		

9.4 Maintenance protocol

The maintenance protocol is included with the attached documents.



ATTENTION: !

Disinfect during each politainer change, or at least every 28 days!

Maintenance of the brine cabin

For the cabins, we recommend to rinse the interior room with water at the end of operations to minimise salt deposits and encrustation.



To protect against germs and bacteria, carry out a disinfection at least every 28 days, as described under *Section 5.2.1, Disinfection and flushing of the Sol-Tec II SL*, and document it in the disinfection protocol! If the device has not been operated for more than 28 days, this must also be documented.

After a down time of more than 28 days, always start the commissioning with a disinfection!

Disinfection / decommissioning	completed	Date	Name
Hose length of the dosing line, max. 30m	_____ m		
Disinfection carried out and water separator emptied	<input type="checkbox"/>		
	<input type="checkbox"/>		
	<input type="checkbox"/>		
	<input type="checkbox"/>		
	<input type="checkbox"/>		
	<input type="checkbox"/>		
	<input type="checkbox"/>		
	<input type="checkbox"/>		
	<input type="checkbox"/>		
	<input type="checkbox"/>		
	<input type="checkbox"/>		
	<input type="checkbox"/>		
	<input type="checkbox"/>		
	<input type="checkbox"/>		
	<input type="checkbox"/>		
	<input type="checkbox"/>		
	<input type="checkbox"/>		
	<input type="checkbox"/>		
	<input type="checkbox"/>		
	<input type="checkbox"/>		
	<input type="checkbox"/>		
	<input type="checkbox"/>		
	<input type="checkbox"/>		
	<input type="checkbox"/>		
	<input type="checkbox"/>		
	<input type="checkbox"/>		
	<input type="checkbox"/>		
	<input type="checkbox"/>		
	<input type="checkbox"/>		
	<input type="checkbox"/>		

9.5 Spare parts list, wear parts list, list of consumables



HINT!

Do you need spare parts, wear parts or consumables? You are welcome to order these from your service partner or your specialist supplier.

Spare part list

Device	Position	Designation	Article no. EOS
Control		Safety bag 2x1,25A Tr, 5x20	16842
		Safety bag 2x315mA Tr 8.3x8	23625
		Control SSD IO circuit board	24341
		Control SSD Touch 3.2"	24305
		Stylus Touch	24168
		Cover	24336
Dosing technology		Hose pump Sa 3.2 Viton, fragrance	13367
		Pressure switch Pak-Mini /Sol-Tec II SL 60mm	10080
		Pressure switch protective cap M10x1	10083
		Canister connection brine coupling	17437
		Canister connection brine plug	24542
		Brine dosing nozzle SL complete, incl. shield, wall bushing and hose line.	20233
		Pneumatic atomiser nozzle Sol-Tec II SL	20086
		Dosing line PTFE 4x1mm	10432
		Union nut 6mm PP ¼"	11003
Pressurised air		Compressor 230V Sol-Tec II SL SL	20228-2
		Air filter for compressors Sol-Tec II SL SL	23145
		Housing base black	16645
		Sol-Tec II SL air filter unit	24534
		Dosing line PE 6x1mm	10435
Disinfection set		Disinfection set Sol-Tec II SL SL	20622

List of consumables

Device	Designation	Article no. EOS
Brine	Brine 5% 1kg in politainer	17519
	Brine 5% 5kg in politainer	17613
	Carton brine 5%: 6x1kg	17669
	Carton brine 5%: 6x5kg	17667
Disinfection	1 tablet SOL-TEC II SL disinfection	19871
	5 tablets SOL-TEC II SL disinfection	24907
	20 tablets SOL-TEC II SL disinfection	24907
	25 tablets SOL-TEC II SL disinfection	19871-1

10 Appendices

Personal notes
